

SERIE AURORA CON E SENZA PREFILTRO
AURORA SERIES WITH OR WITHOUT PREFILTER



Serie Aurora con prefiltra
Aurora series with prefilter



Serie Aurora senza prefiltra
Aurora series without prefilter

Impieghi

- Circolazione dell'acqua in impianti di filtrazione per piscine
- Ideale per portate elevate a bassa pressione

Uses

- Water circulation in swimming pool filtration systems
- Ideal for high flow at low pressure

Corpo

- Corpo pompa e pre-filtro in polipropilene rinforzato con fibra di vetro
- Girante bronzea o plastica a seconda del modello
- Albero e cestello del pre-filtro in acciaio inossidabile

Body

- Body pump and pre-filter made of reinforced polypropylene with fiberglass
- Bronze or plastic impeller depending on the model
- Shaft and pre-filter drum in stainless steel

Motore

- Motore trifase con rotazione a 3000 r.p.m.
- 230/400 V o 380/600 V (modelli con potenza superiore a 7,5 HP), 50 Hz
- Protezione IP 55
- Classe di isolamento F

Motor

- Three-phase Motor-rotating at 3000 r.p.m.
- 230/400 V or 380/600 V (models with higher power to 7.5 HP), 50 Hz
- IP-55 Protection
- Class-F insulation

Codice	Descrizione
POMPE AURORA CON PREFILTRO / PUMP AURORA WITH PREFILTER	
1090184	Pompa Aurora con prefiltra 3 HP / pump with prefilter 3 HP
1090170	Pompa Aurora con prefiltra 4 HP / pump with prefilter 4 HP
1090171	Pompa Aurora con prefiltra 5,5 HP / pump with prefilter 5,5 HP
1090172	Pompa Aurora con prefiltra 7,5 HP / pump with prefilter 7,5 HP
1090173	Pompa Aurora con prefiltra 10 HP / pump with prefilter 10 HP
1090174	Pompa Aurora con prefiltra 12,5 HP / pump with prefilter 12,5 HP
POMPE AURORA SENZA PREFILTRO / PUMP AURORA WITHOUT PREFILTER	
1090175	Pompa Aurora senza prefiltra 4 HP / pump without prefilter 4 HP
1090176	Pompa Aurora senza prefiltra 5,5 HP / pump without prefilter 5,5 HP
1090177	Pompa Aurora senza prefiltra 7,5 HP / pump without prefilter 7,5 HP
1090178	Pompa Aurora senza prefiltra 10 HP / pump without prefilter 10 HP
1090179	Pompa Aurora senza prefiltra 12,5 HP / pump without prefilter 12,5 HP

AURORA MODELLI 3HP, 4HP E 5,5HP CON PREFILTRO
AURORA MODEL 3HP, 4HP AND 5,5 HP WITH PREFILTER

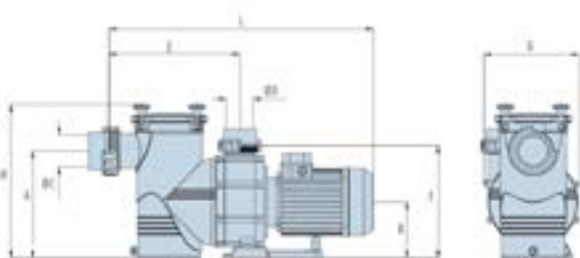

Mod.	A mm	B mm	C mm	D mm	E mm	F mm	G mm	H mm	L mm
3	300	160	Ø90	Ø75	368	320	264	431	713
4	300	160	Ø90	Ø75	368	320	264	431	743
5,5	300	160	Ø90	Ø75	368	320	264	431	743

Modello	Potenza HP	Potenza kW	A 3~		H mm	Q m³/h
			230 V 50Hz	400 V 50Hz		
3	3	2,2	8,0	4,8	12	43
4	4	2,9	12,6	7,3	12	64
5,5	5,5	4	14,9	8,6	12	71

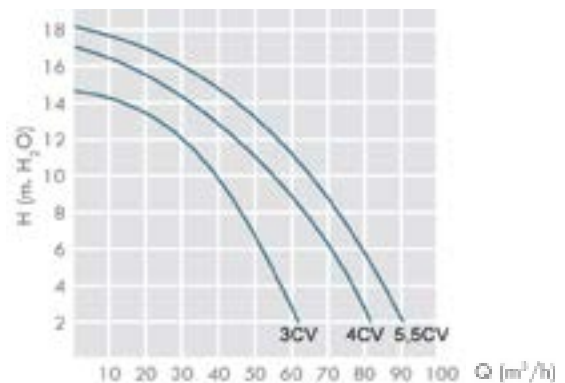

AURORA MODELLI 7,5 - 10 - 12,5 HP CON PREFILTRO
 AURORA MODEL 7,5 - 10 - 12,5 HP WITH PREFILTER

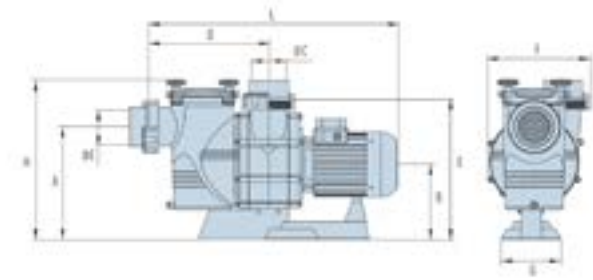

A	B	C	D	E	F	G	H
mm	mm	mm	mm	mm	mm	mm	mm
375	255	110	405	470	330	200	534

Modello	Potenza HP	Potenza kW	A 3 ~		H mm	Q m³/h
			230 V 50Hz	400 V 50Hz		
7,5	7,5	5,5	22,5	13,3	12	110
10	10	7,4	30,5	17,6	12	125
12,5	12,5	9,2	40	23,3	12	140

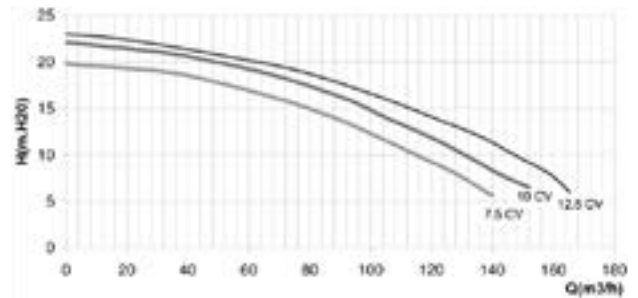

AURORA MODELLI SENZA PREFILTRO
 AURORA MODEL WITHOUT PREFILTER

Modello	A mm	B mm	C mm	D mm	F mm	G mm	H mm	L mm
4	255	255	90	105	330	200	470	510
5,5/7,5	255	255	110	105	330	200	470	530
10	255	255	110	105	330	200	470	600
12,5	255	255	110	105	330	200	470	645

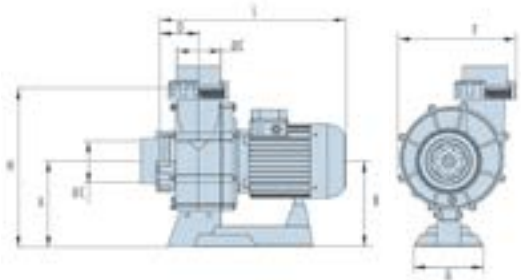

Modello	Potenza HP	Potenza kW	A 3 ~	
			230 V - 50Hz	400 V - 50Hz
4	4	2,9	13,2	7,6
5,5	5,5	4	17,9	10,3
7,5	7,5	5,5	13,3	7,6
10	10	7,4	17,6	9,5
12,5	12,5	9,2	23,3	12,1

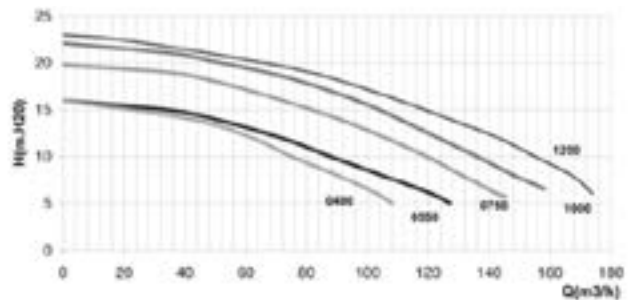



SERIE RIVER
SERIES RIVER

Pompe centrifughe Vienna e River complete di prefiltro, per circolazione dell'acqua in impianti di filtrazione per piscine

Vienna and River centrifugal pumps complete with prefilter, for circulation in swimming pools.



Materiali serie River

- Corpo pompa, prefiltro, diffusore, coperchio pompa, coperchio connessioni, filtro e girante in PPO.
- Albero in acciaio inossidabile AISI 304.
- Tenuta meccanica in sic-sic

Motore

- Asincrono, due poli.
- Protezione IP 55.
- Isolamento classe F
- Funzionamento continuo

Materials River serie

- Pump body, prefilter, diffuser, pump cover, connection cover, filter and impeller in PPO.
- Shaft in stainless steel AISI 304.
- Mechanical seal in sic-sic

Motor

- Asynchronous, two poles.
- IP 55 protection.
- Class F insulation.
- Continuous operation

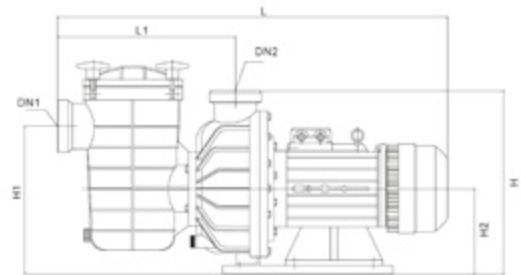
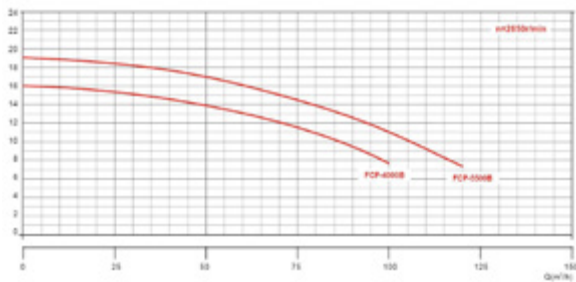

Modello	L mm	L1 mm	H mm	H1 mm	H2 mm	DN1 mm	DN2 mm
River FCP-4000B	841	420	418	266	166	ø110	ø110
River FCP-5500B	886	420	418	266	166		

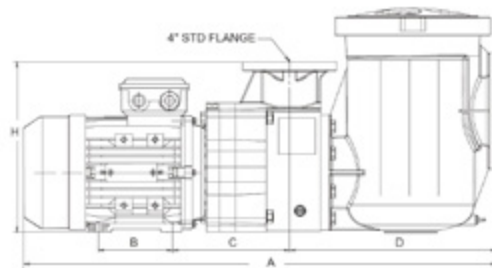
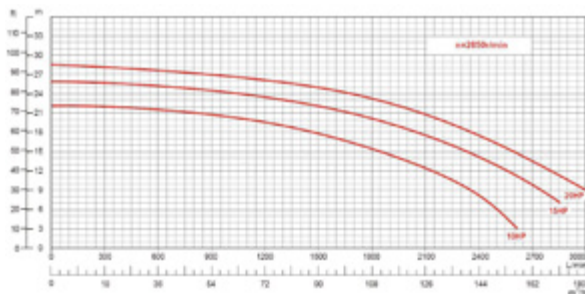

Modello	A mm	B mm	C mm	D mm	F mm	G mm	H mm	H ₁ mm	H ₂ mm	K mm
River FCP-10AN	1145	140	298	508	483	216	415	295	546	12
River FCP-15AN	1330	210	305	508	483	216	415	295	546	12
River FCP-20AN	1330	210	305	508	483	216	415	295	546	12

Codice	Modello	Potenza HP	Potenza kW	H m	Q m³/h	H m	Q m³/h	V	
								3 ~ 50	400 V
2220275	Vienna 400S*	4	3	8	54	12	43,5	400	6.4
1090141	River FCP-4000B	5,5	4	8	95	12	70	400	8.3
1090142	River FCP-5500B	7,5	5,5	8	115	12	95	400	11.1
1090143	River FCP-10AN	10	7,5	8	144	12	128	400	14.9
1090144	River FCP-15AN	15	11	8	175	12	155	400	21
1090145	River FCP-20AN	20	15	9	180	12	168	400	28

*Per il modello Vienna 400S vedere pagina 135 / For the Vienna 400S model look at page 135

POMPE SERIE GHISA NM / CAST IRON NM PUMPS



Pompa in ghisa con tenuta in carbone speciale impregnato con resina/ceramica/FPM per acqua clorata.

Cast iron with special carbon sealing resin/ceramic/FPM impregnated for chlorinated water.

Impieghi

- Per liquidi puliti senza parti abrasive, non aggressivi per i materiali della pompa (con parti solide fino a 0,2% max)
- Per l'approvvigionamento d'acqua
- Per applicazioni civili e industriali

Uses

- For clean liquids without abrasives, which are non-aggressive for the pump materials (solids content up to 0,2%)
- For water supply
- For civil and industrial applications.

Motore

- Motore ad induzione 2 poli, 50 Hz (n ≈ 2900 l/min)
- Trifase 230/400 V ± 10%, fino a 3 kW; 400/690 V ± 10%, da 4 a 75 kW
- Isolamento classe F. Protezione IP 54
- Temperatura liquido: da -10 °C a +90 °C
- Temperatura ambiente fino a 40 °C
- Altezza aspirazione manometrica fino a 7 m
- Pressione finale massima ammessa nel corpo pompa: 10 bar

Motor

- 2-pole induction motor, 50 Hz (n ≈ 2900 rpm)
- three-phase 230/400 V ± 10% up to 3 kW; 400/690 V ± 10% from 4 to 75 kW
- Insulation class F. Protection IP 54
- Liquid temperature from -10 °C to +90 °C.
- Ambient temperature up to 40° C.
- Total suction lift up to 7 m.
- Maximum permissible working pressure up to 10 bar

Codice	Descrizione
1090130	Pompa in ghisa senza prefiltro NM 40/12A/C tri / pump without prefilter NM 40/12A/C
1090131	Pompa in ghisa senza prefiltro NM 40/16B/B tri / pump without prefilter NM 40/16B/B
1090132	Pompa in ghisa senza prefiltro NM 40/20C/B tri / pump without prefilter NM 40/20C/B
1090133	Pompa in ghisa senza prefiltro NM 40/20AR/A tri / pump without prefilter NM 40/20AR/A

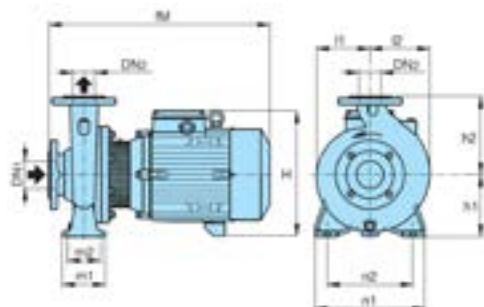

Modello	DN1 mm	DN2 mm	fM mm	h1 mm	h2 mm	H mm	m1 mm	m2 mm	n1 mm	n2 mm	l1 mm	l2 mm
40/12A/B	65	40	450	112	140	240	100	70	210	160	100	113
40/16B/B	65	40	475	132	160	270	100	70	240	190	119	119
40/20C/A	65	40	495	160	180	298	100	70	265	212	140	140
40/20AR/A	65	40	525	160	180	320	100	70	265	212	140	140

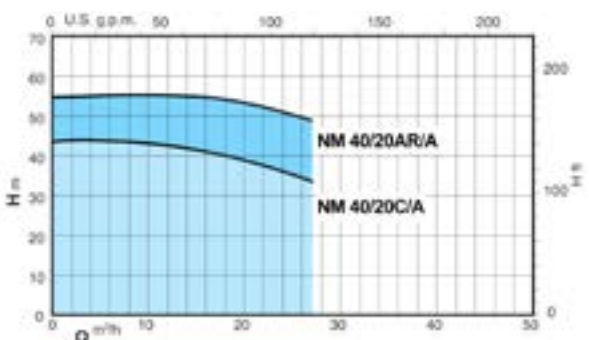
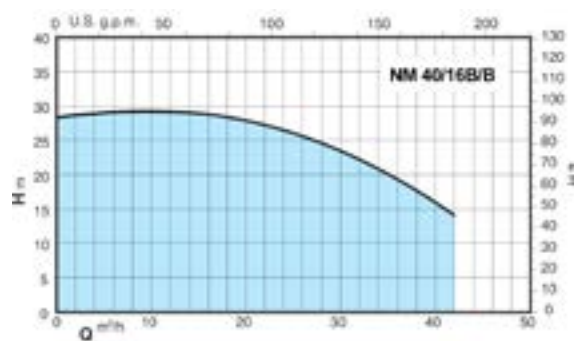
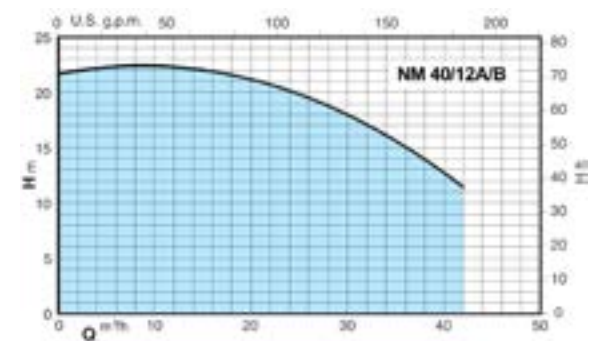

Modello	Potenza kW	Potenza HP	230 V Δ 400 V Y			H m	Q m³/h
			400 V Δ 690 V Y				
			In A	In A	In A		
40/12A/B	2,2	3	9,2	5,3	-	13,0	39
40/16B/B	3	4	11,5	6,6	-	14,0	42
40/20C/A	4	5,5	-	9,6	5,5	33,5	27
40/20AR/A	5,5	7,5	-	10,8	6,2	49,0	27

POMPE SERIE GHISA NM4 / CAST IRON NM4 PUMPS



Pompa in ghisa con tenuta in carbone speciale impregnato con resina/ceramica/FPM per acqua clorata.

Cast iron with special carbon sealing resin/ceramic/FPM impregnated for chlorinated water.

Impieghi

- Per liquidi puliti senza parti abrasive, non aggressivi per i materiali della pompa (con parti solide fino a 0,2% max)
- Per l'approvvigionamento d'acqua
- Quando è richiesto un funzionamento con rumorosità ridotta

Uses

- For clean liquids without abrasives, which are non-aggressive for the pump materials (solids content up to 0,2%)
- For water supply
- When low noise operating is required

Motore

- Motore ad induzione a 4 poli, 50 Hz (n ≈ 1450 1/min)
- Trifase 230/400 V ± 10%, fino a 3 kW ; 400/690 V ± 10%, da 4 a 75 kW
- Isolamento classe F. Protezione IP 54
- Temperatura liquido: da -10 °C a +90 °C
- Temperatura ambiente fino a 40 °C
- Altezza aspirazione manometrica fino a 7 m
- Pressione finale massima ammessa nel corpo pompa: 10 bar

Motor

- 2-pole induction motor, 50 Hz (n ≈ 2900 rpm)
- three-phase 230/400 V ± 10% up to 3 kW; 400/690 V ± 10% from 4 to 75 kW
- Insulation class F. Protection IP 54
- Liquid temperature from -10 °C to +90 °C.
- Ambient temperature up to 40° C.
- Total suction lift up to 7 m.
- Maximum permissible working pressure up to 10 bar

Codice	Descrizione
1090134	Pompa in ghisa senza prefiltro NM4 40/25B/C tri / pump without prefilter NM4 40/25B/C
1090135	Pompa in ghisa senza prefiltro NM4 40/25A/B tri / pump without prefilter NM4 40/25A/B
1090136	Pompa in ghisa senza prefiltro NM4 65/25B/B tri / pump without prefilter NM4 65/25B/B
1090137	Pompa in ghisa senza prefiltro NM4 65/31C/B tri / pump without prefilter NM4 65/31C/B
1090138	Pompa in ghisa senza prefiltro NM4 80/25A/B tri / pump without prefilter NM4 80/25A/B
1090139	Pompa in ghisa senza prefiltro NM4 80/31C/B tri / pump without prefilter NM4 80/31C/B

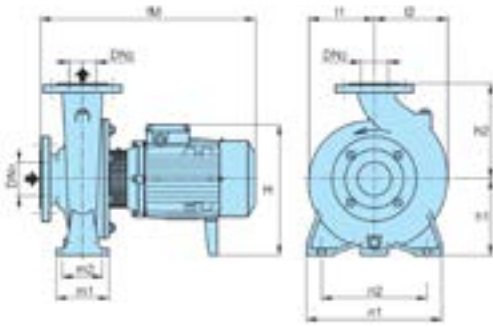

Modello	DN1 mm	DN2 mm	fM mm	h1 mm	h2 mm	H mm	m1 mm	m2 mm	n1 mm	n2 mm	l1 mm	l2 mm
40/25B/B	65	40	495	180	225	308	125	95	320	250	175	175
40/25A/B	65	40	525	180	225	340	125	95	320	250	175	175
65/25B/A	80	65	540	200	250	360	160	120	360	280	175	190
65/31C/B	80	65	670	225	280	410	160	120	400	315	220	220
80/25A/B	100	80	745	200	280	385	160	120	400	315	191	210
80/31C/B	100	80	745	250	315	435	160	120	400	315	220	232

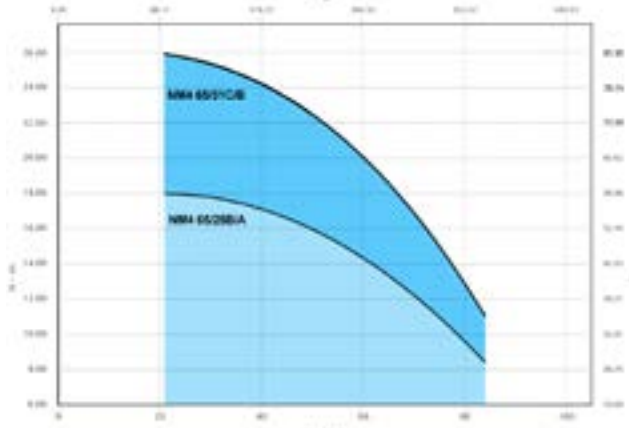
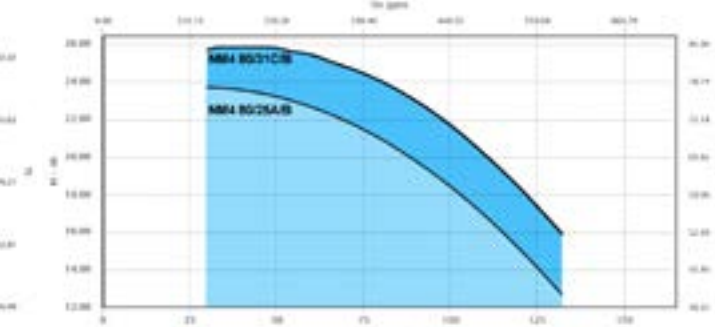
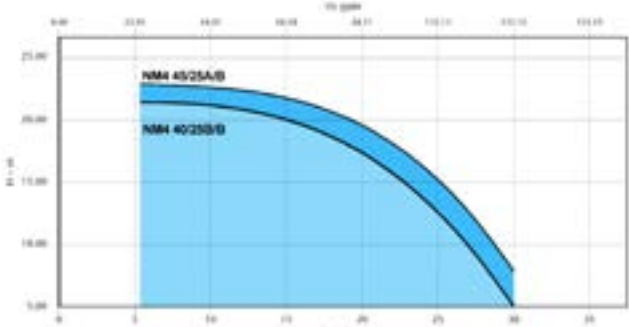

Modello	Potenza kW	Potenza HP	230 V Δ 400 V Y			H m	Q m³/h
			400 V Δ 690 V Y				
			In A	In A	In A		
40/25B/B	2,2	3	8,6	5,0	-	10,0	27
40/25A/B	3	4	11,1	6,4	-	12,6	27
65/25B/A	4	5,5	-	8,3	4,8	13,1	66
65/31C/B	5,5	7,5	-	12,5	7,2	15,0	75
80/25A/B	7,5	10	-	16,0	9,2	15,1	120
80/31C/B	9,2	12,5	-	19,0	11,0	18,3	120

PISCINE PUBBLICHE