

SCALE SOTTO LINER / UNDER LINER STAIRS



Scala angolo posa liner - Corner stairs laying of the liner



Scale ad angolo - Corner stairs



Scale con panca - Stairs with sitting



SCALA ROMANA / ROMAN STAIRS



Codice	Descrizione	Lunghezza	Altezza [m]	N° scalini
1030250	Scala romana Roman stair	2,50 m	1,20	3
1030273	Scala romana Roman stair	3,00 m	1,50	4

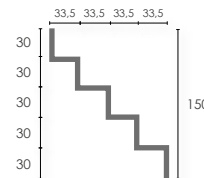
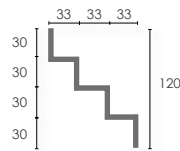

SCALA AD ANGOLO CON SEDUTA / ANGLED STAIRS WITH SEAT

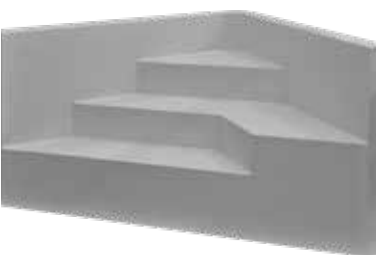

Codice	Descrizione	Larghezza interna	Altezza	Numero scalini
1030251	Scala ad angolo con seduta Angled stair with seat	1,75 mx1,75 m	1,20	3

SCALA AD ANGOLO / ANGLED STAIRS



Codice	Descrizione	Larghezza interna [m]			Altezza [m]	Numero scalini
		A	B	C		
1030253	Scala ad angolo Angled stair	2,40	1,70	1,70	0,90	3
1030276	Scala ad angolo Angled stair	2,50	1,77	1,77	1,20	4

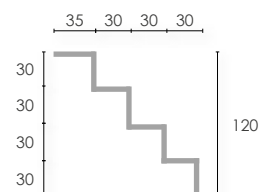
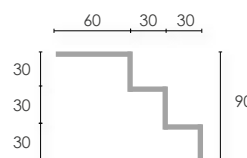
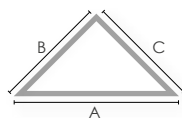

SCALE CON PANCA CON KIT IDROMASSAGGIO
STAIRS WITH SITTING COMPLETE WITH HYDROMASSAGE JETS KIT

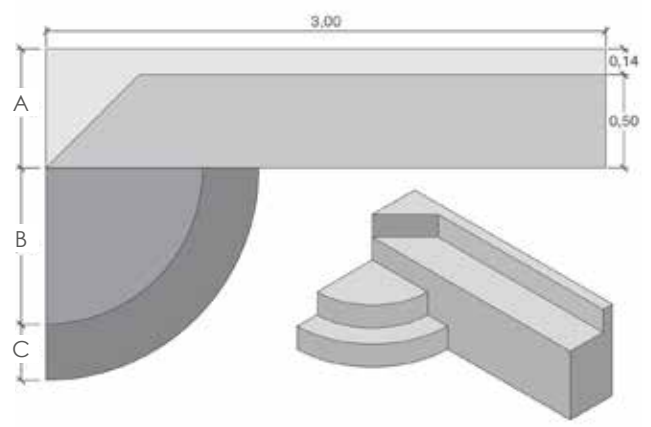
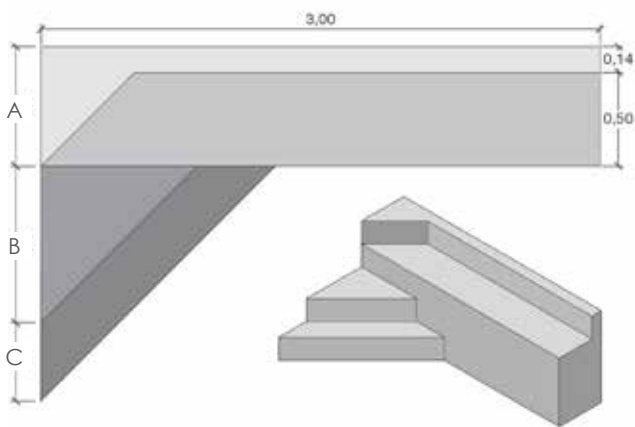

cod.1030410 (N°2 scalini) - cod. 1030413 (N°1 scalino)



cod.1030411 (N°2 scalini) - cod. 1030414 (N°1 scalino)

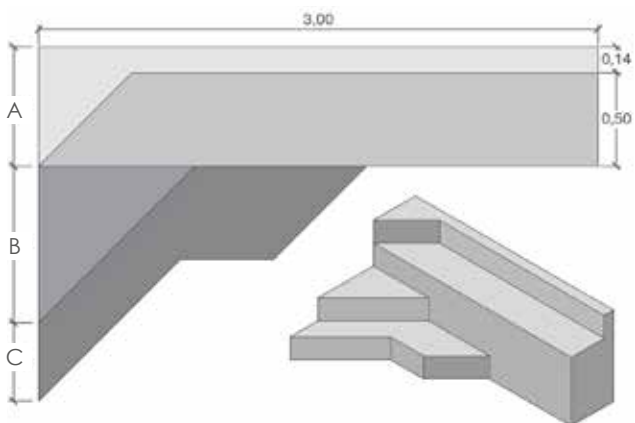

cod. 1030416 (N°2 scalini)

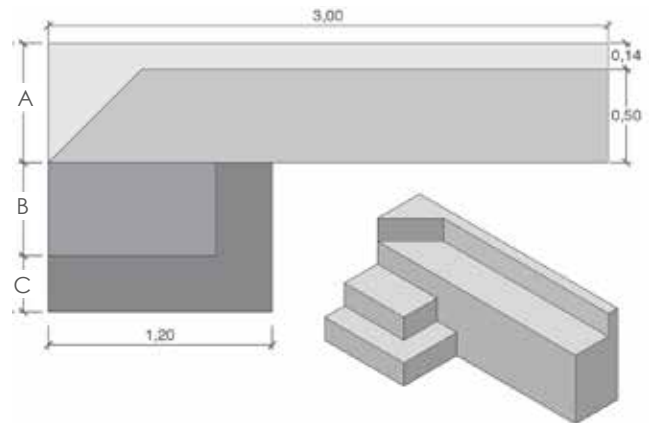

cod.1030412 (N°2 scalini) - cod. 1030415 (N°1 scalino)



Codice	Modello	Dimensioni [cm]			Altezza totale [cm]	N° scalini	N° scalini totale	Prezzo
		A	B	C				
ALTEZZA SEDUTA 90 cm- LUNGHEZZA TOTALE 300 cm - sitting height 90 cm - total length 300 cm								
1030410	Scala ad angolo con panca / Corner stair with sitting	64	84	42	120	2	4	
1030416	Scala ad angolo estesa con panca / Extended corner stair w/sitting	64	84	42	120	2	4	
1030411	Scala circolare con panca / Round corner stair with sitting	64	84	30	120	2	4	
1030412	Scala angolo retto con panca / Square corner stair with sitting	64	50	30	120	2	4	
ALTEZZA SEDUTA 60 cm- LUNGHEZZA TOTALE 300 cm - sitting height 60 cm - total length 300 cm								
1030413	Scala ad angolo con panca / Corner stair with sitting	64	84	-	90	1	3	
1030414	Scala circolare con panca / Round corner stair	64	84	-	90	1	3	
1030415	Scala angolo retto con panca / Square corner stair with sitting	64	50	-	90	1	3	
MODULO ESTENSIONE PANCA - BENCH EXTENSION MODULE								
1030420	Modulo estensione panca - H 60 cm / bench extension module - H 60 cm							al m
1030421	Modulo estensione panca - H 90 cm / bench extension module - H 90 cm							al m

KIT IDROMASSAGGIO ABBINABILI (MONOFASE) combinable hydromassage kits	kit idro 4 bocchette		kit idro 8 bocchette		kit idro 10 bocchette	
	codice	prezzo	codice	prezzo	codice	prezzo
A - Kit bocchette idro e raccorderia A - Hydromassage jets, fittings and pipes	1030417		1030418		1030419	
B - Kit impianto idromassaggio (blower,quadro,pompa, senza locale tecnico) B - Hydromassage system kit (blower, panel, pump, no technical housing)	1030422		1030423		1030424	
C - Kit impianto idromassaggio (blower,quadro,pompa con locale tecnico vtr) C - Hydromassage system kit (blower, panel,pump, with technical housing)	1030425		1030426		1030427	

Kit idromassaggio completo A+B oppure A+C / Complete hydromassage kit A+B or A+C

SCALA AD ANGOLO CON SEDUTA / ANGLED STAIRS WITH SEAT



Codice	Descrizione	Larghezza interna [m]			Altezza [m]	N° scalini
		A	B	C		
1030367	Scala ad angolo con seduta Angled stair with seat	2,40	1,70	1,70	0,90	3
1030368	Scala ad angolo con seduta Angled stair with seat	3,00	2,12	2,12	1,20	4

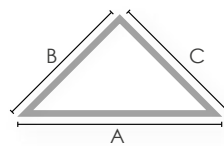

SCALA CIRCOLARE / ROUND STAIRS

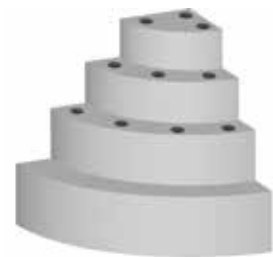

Codice	Descrizione	R raggio esterno [mm]	Altezza [m]	Numero scalini
1030272	Scala circolare Round stair	1300	0,90	3
1030257	Scala circolare Round stair	1600	1,20	4

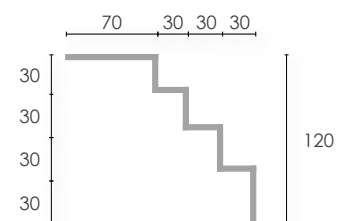
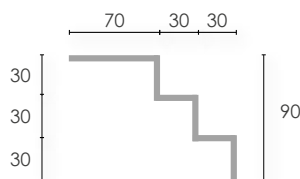

SCALA DRITTA / STRAIGHT STAIRS



Codice	Descrizione	Lunghezza modulare	Altezza [m]	Numero scalini
1030260	Scala dritta <i>Straight stair</i>	1,00 m	0,90	3
1030355	Scala dritta <i>Straight stair</i>	2,00 m	0,90	3
1030356	Scala dritta <i>Straight stair</i>	2,50 m	0,90	3
1030357	Scala dritta <i>Straight stair</i>	3,00 m	0,90	3
1030262	Scala dritta <i>Straight stair</i>	1,00 m	1,20	4
1030358	Scala dritta <i>Straight stair</i>	2,00 m	1,20	4
1030359	Scala dritta <i>Straight stair</i>	2,50 m	1,20	4
1030360	Scala dritta <i>Straight stair</i>	3,00 m	1,20	4

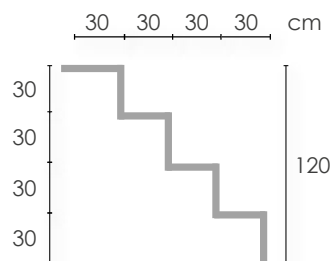
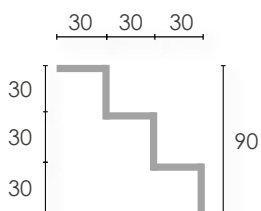

SCALA RELAX / RELAX STAIRS



Codice	Descrizione	Lunghezza	Altezza [m]	Numero scalini
1030270	Scala relax / <i>relax stair</i>	1,00 m	0,90	3
1030361	Scala relax / <i>relax stair</i>	2,00 m	0,90	3
1030362	Scala relax / <i>relax stair</i>	2,50 m	0,90	3
1030363	Scala relax / <i>relax stair</i>	3,00 m	0,90	3
1030475	Scala relax / <i>relax stair</i>	1,00 m	1,20	4
1030364	Scala relax / <i>relax stair</i>	2,00 m	1,20	4
1030365	Scala relax / <i>relax stair</i>	2,50 m	1,20	4
1030366	Scala relax / <i>relax stair</i>	3,00 m	1,20	4

