

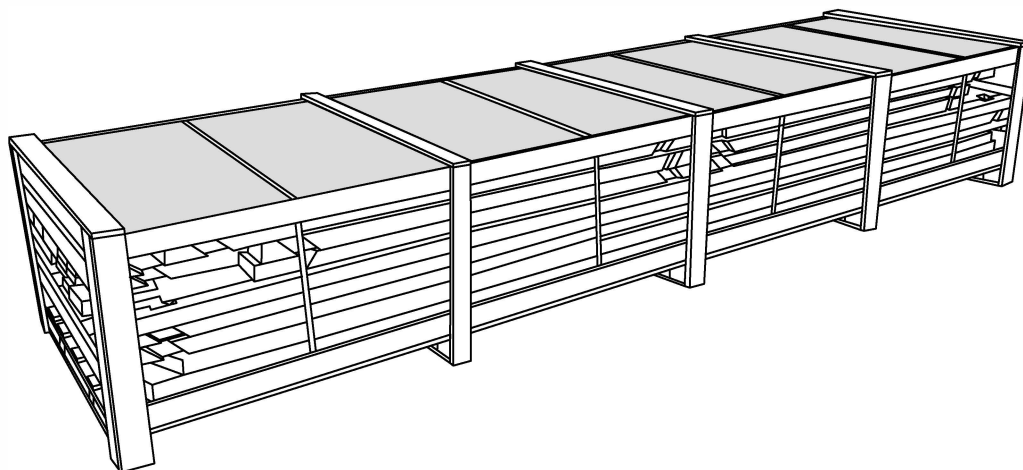

NIAGARA 600

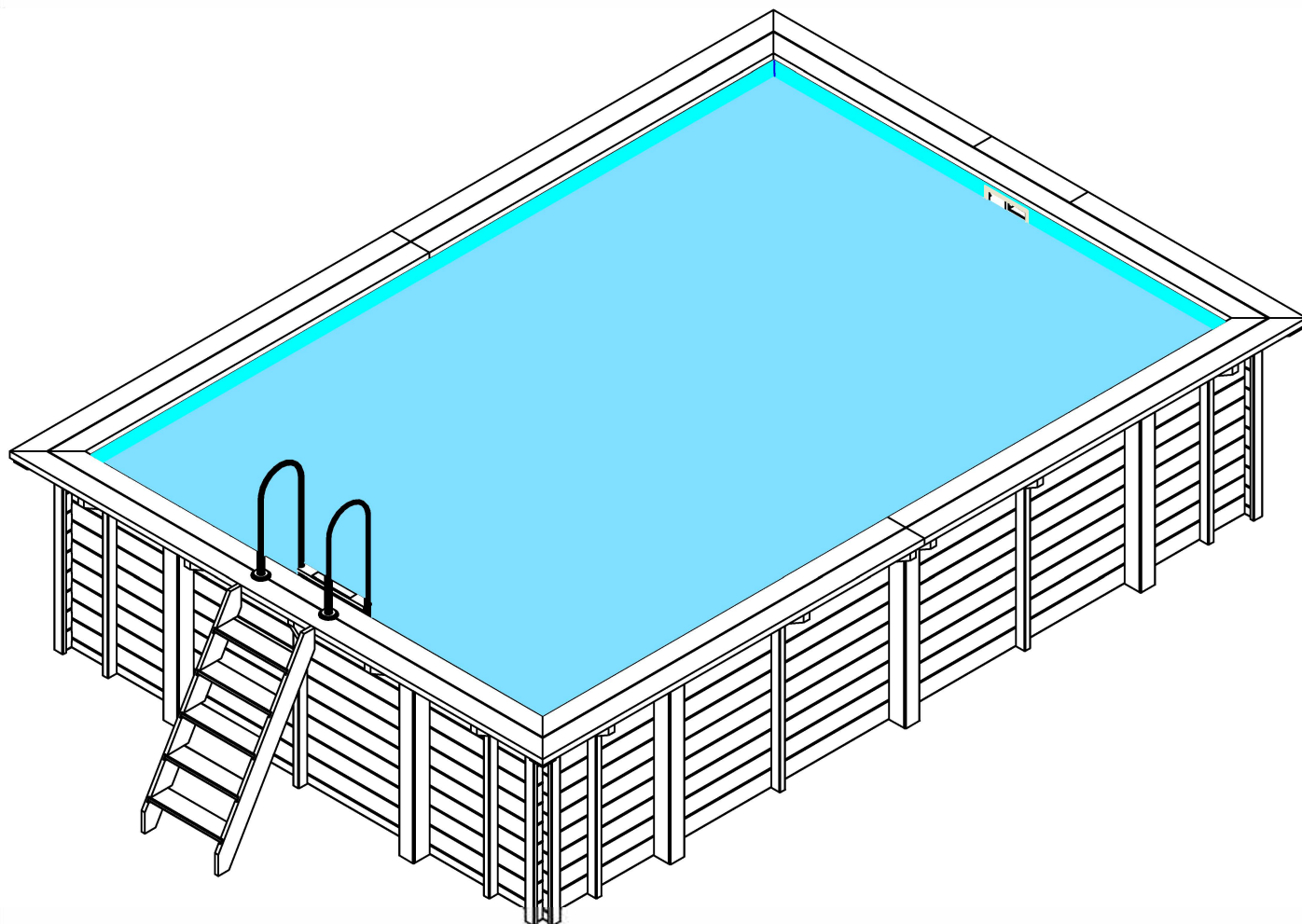

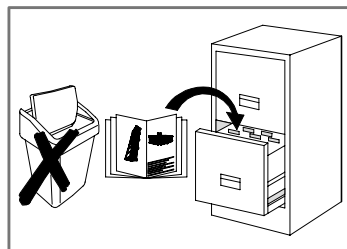
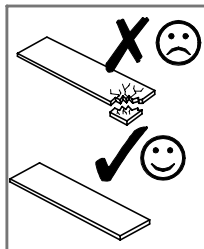
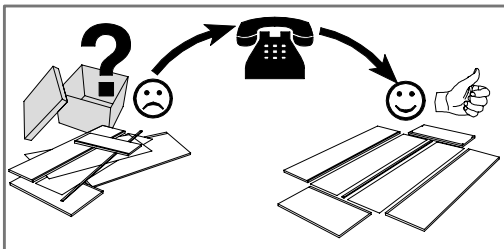
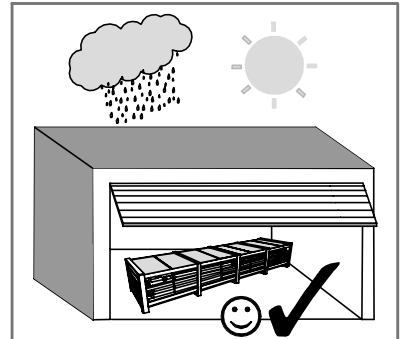
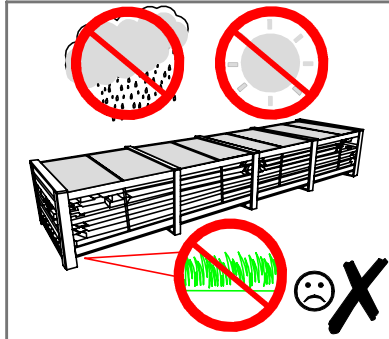
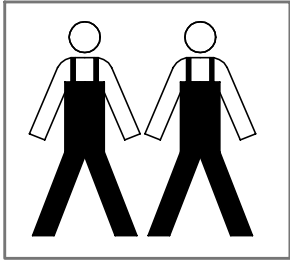
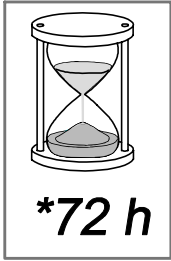

REGULAR MAINTENANCE



OIL

VERY IMPORTANT!

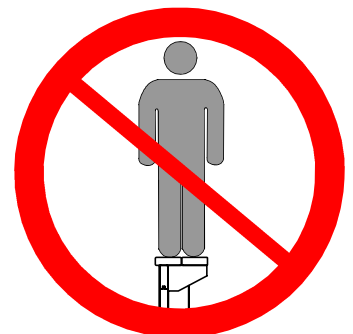

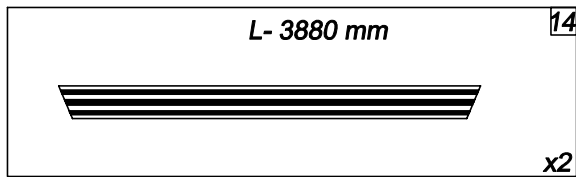
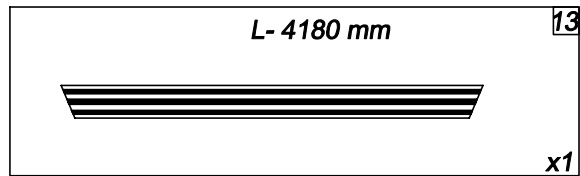
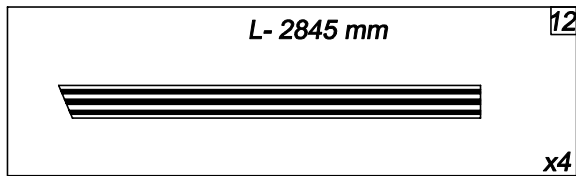
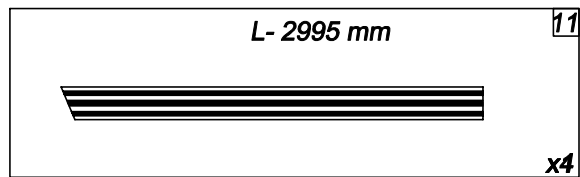
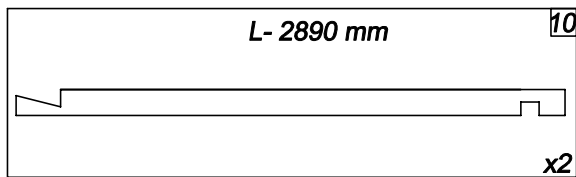
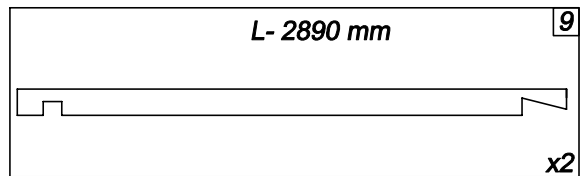
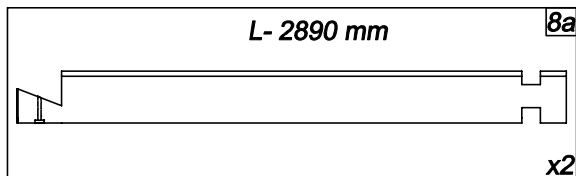
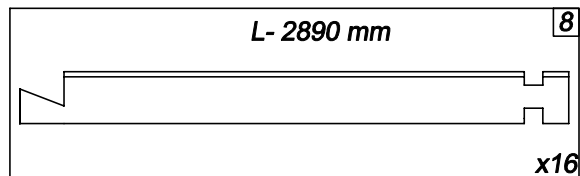
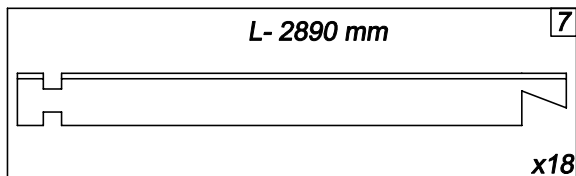
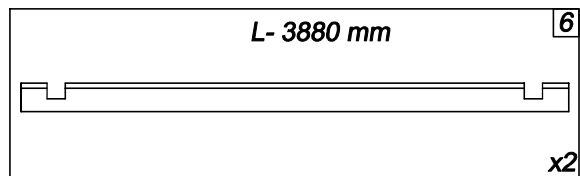
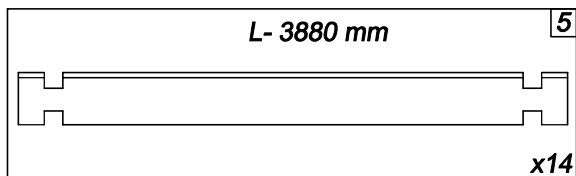
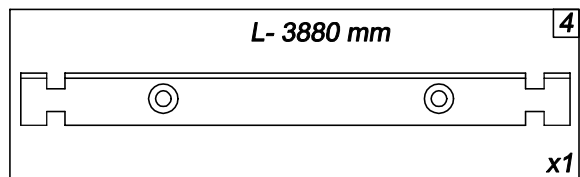
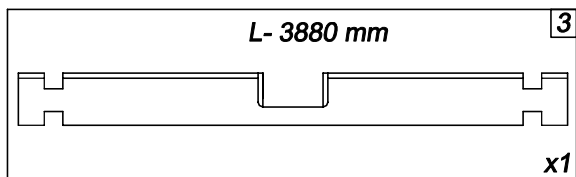
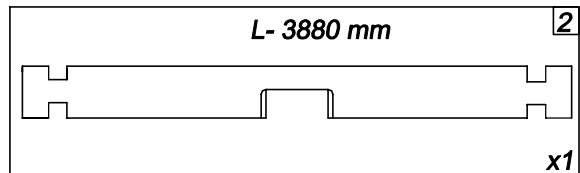
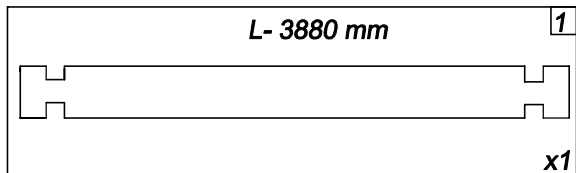
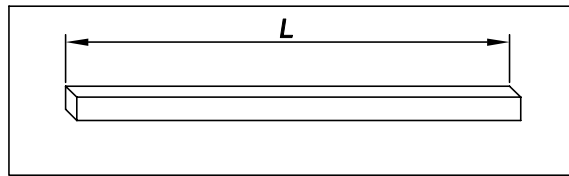

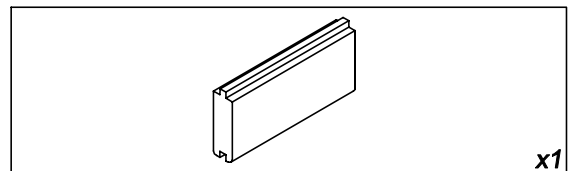
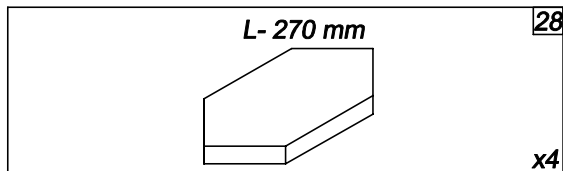
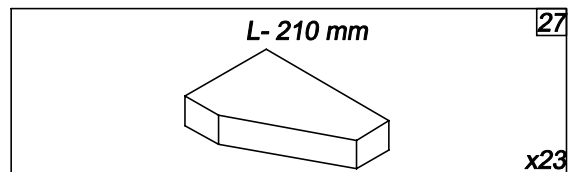
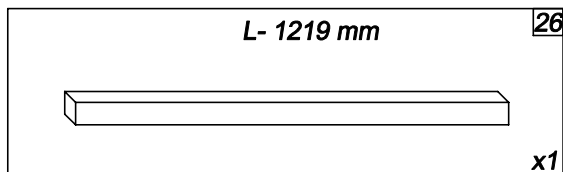
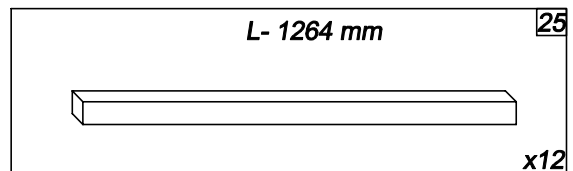
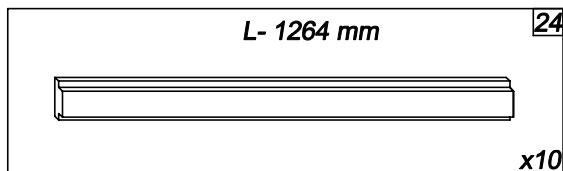
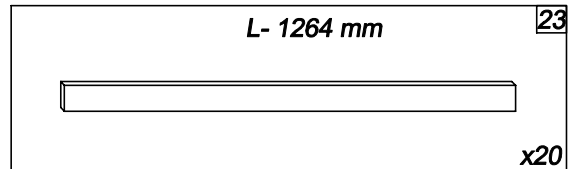
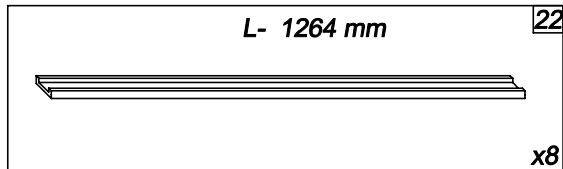
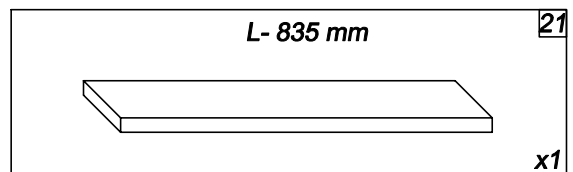
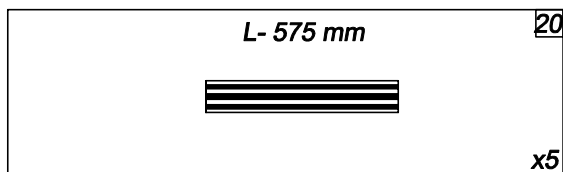
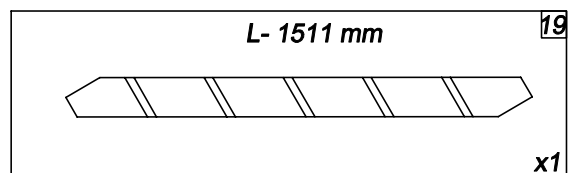
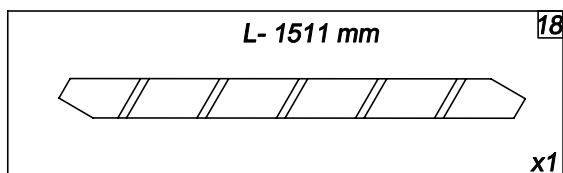
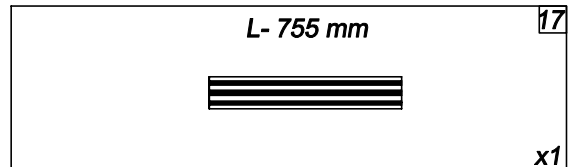
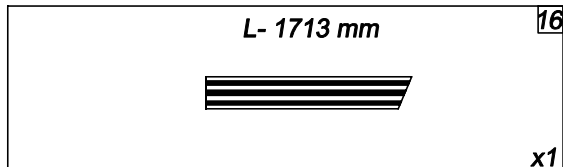
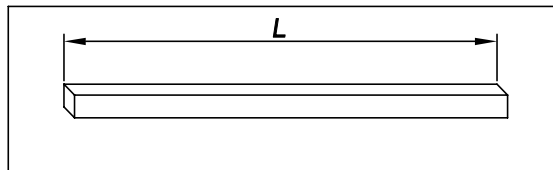

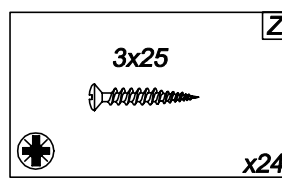
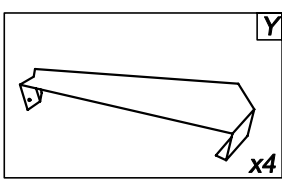
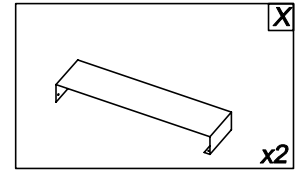
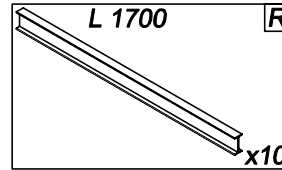
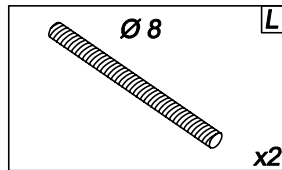
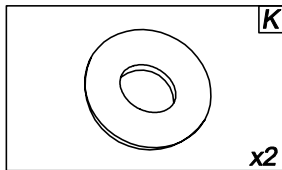
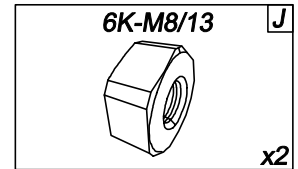
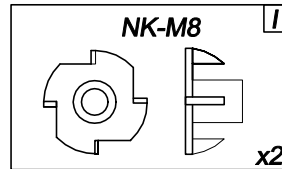
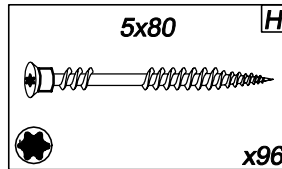
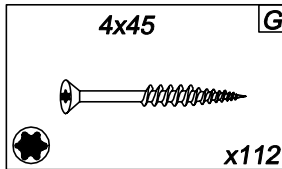
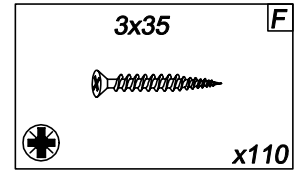
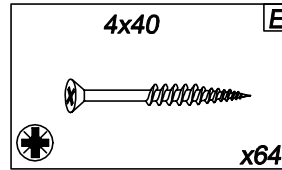
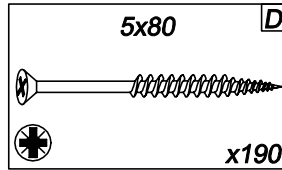
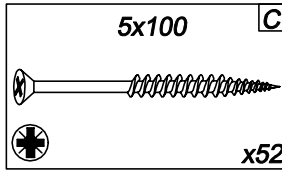
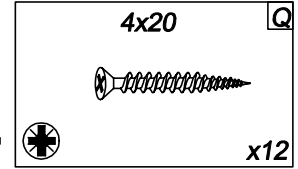
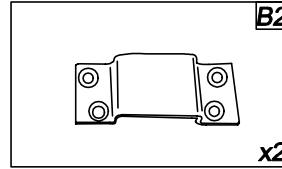
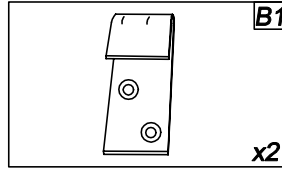
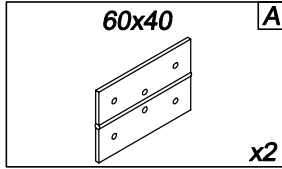

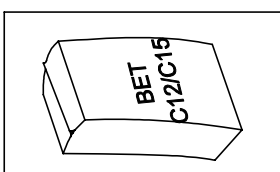
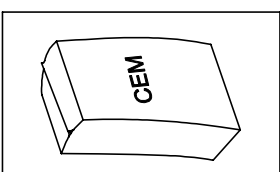
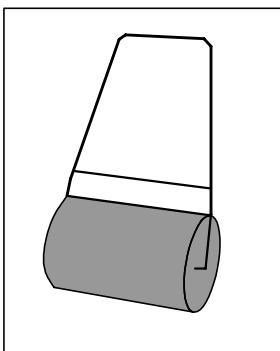
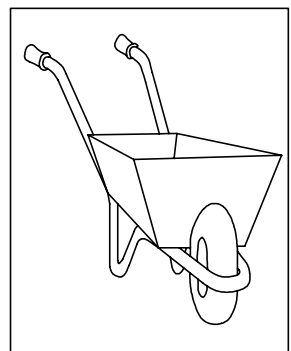
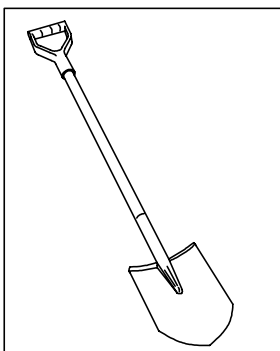
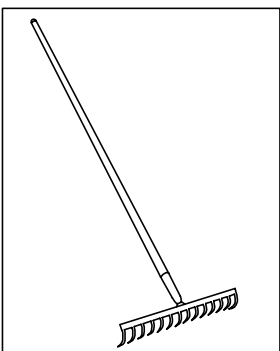
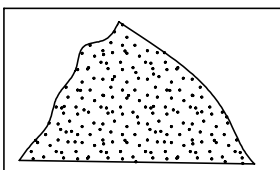
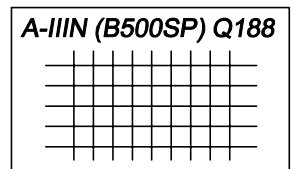
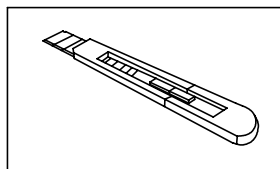
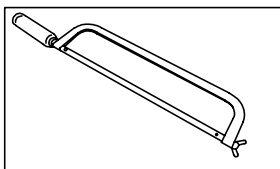
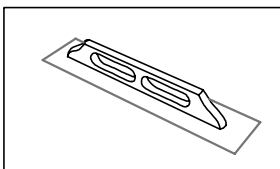
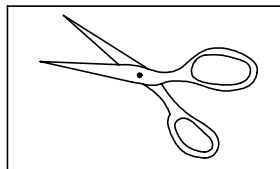
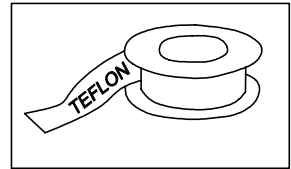
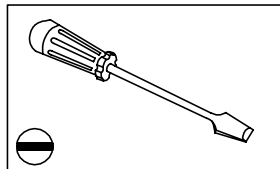
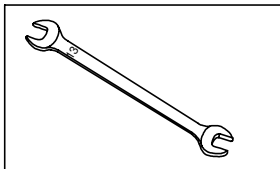
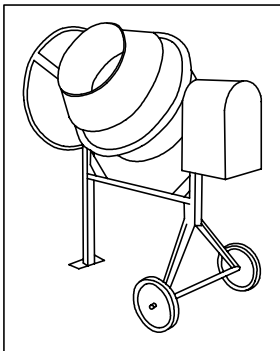
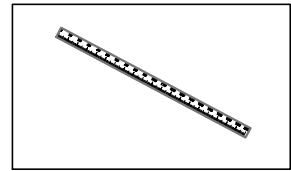
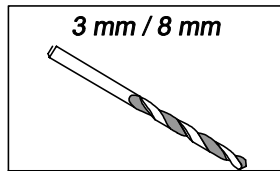
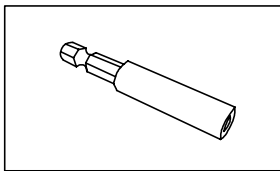
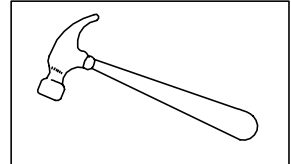
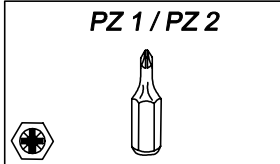
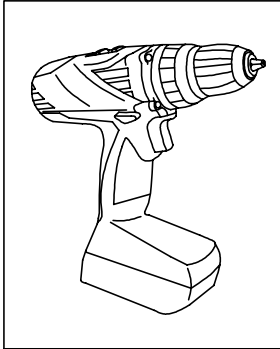
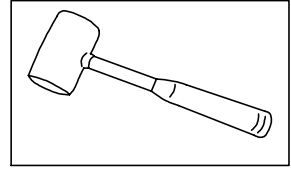
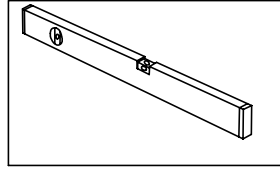
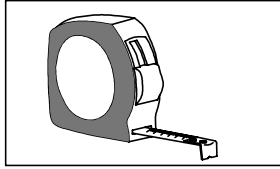
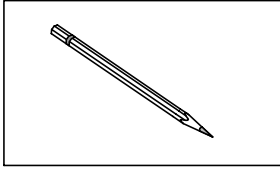

PL Podłoże

GB Ground

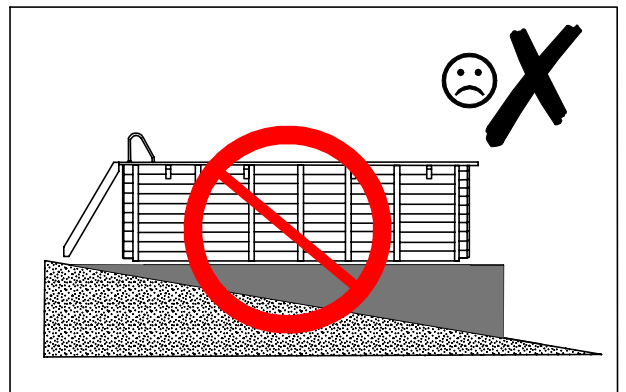
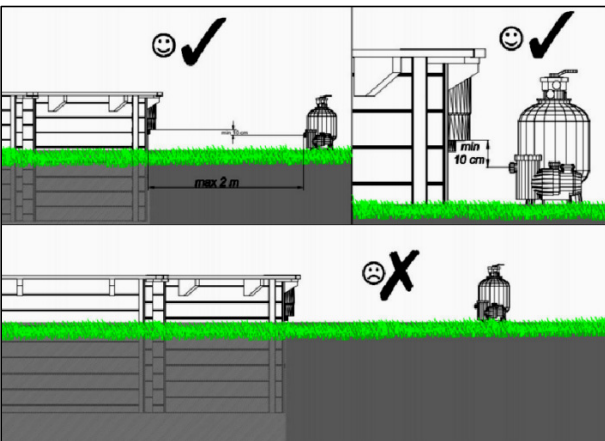
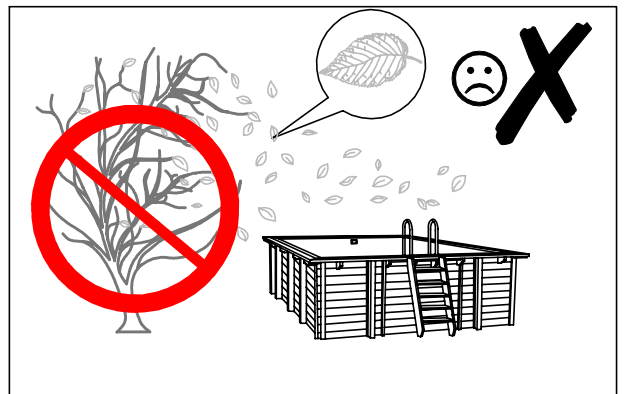
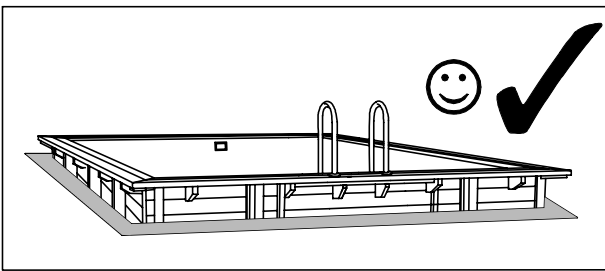
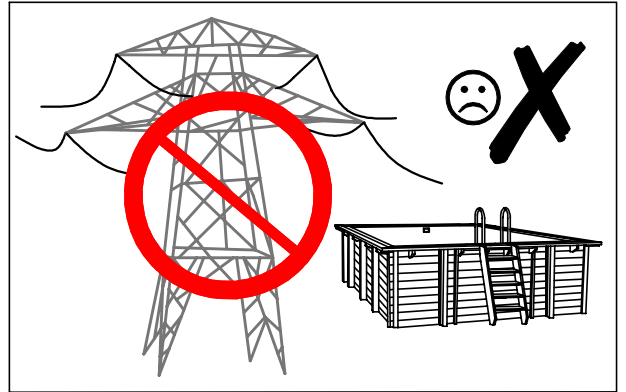
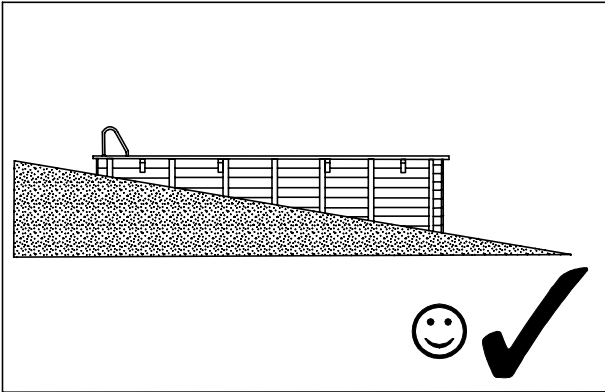
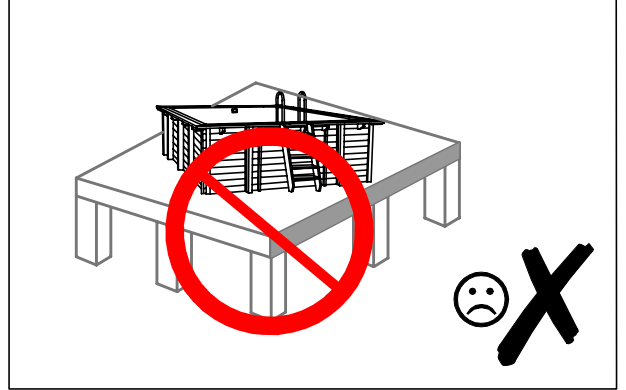
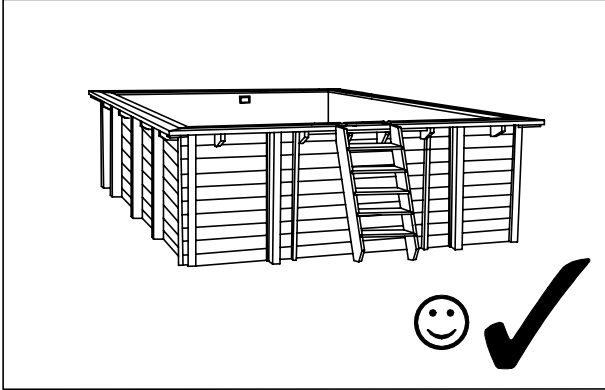

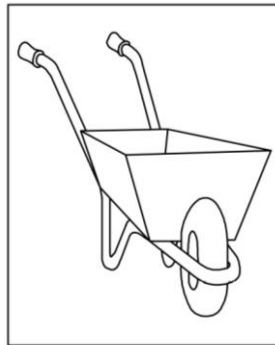
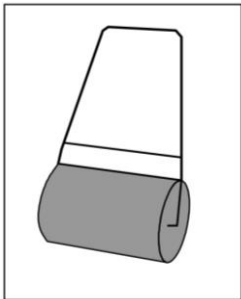
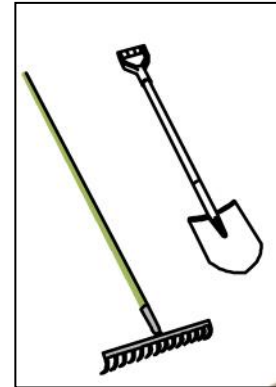
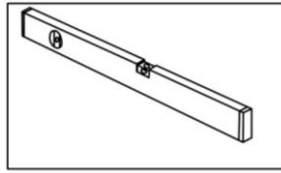

INDICAZIONE QUOTE DI SCAVO
INDICATION OF EXCAVATION DIMENSIONS

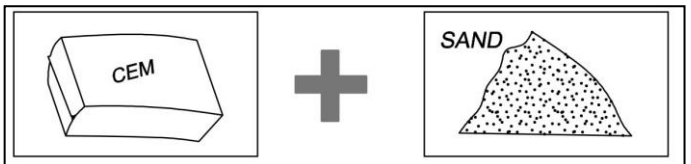
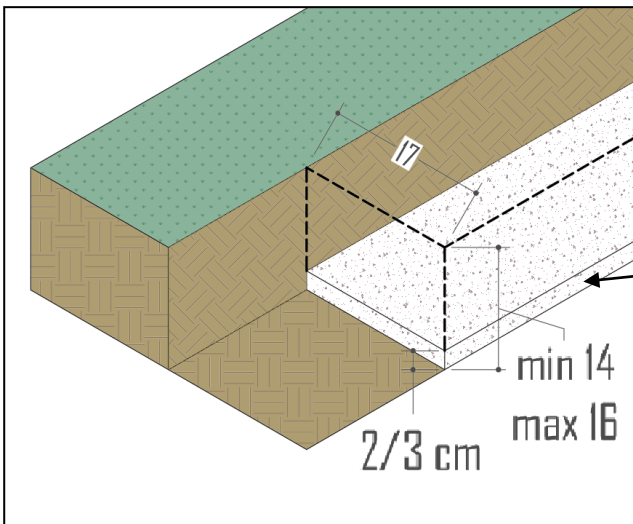

RACCOMANDATO SPESSORE DI CIRCA 2-3 cm
THICKNESS RECOMMENDED 2-3 cm

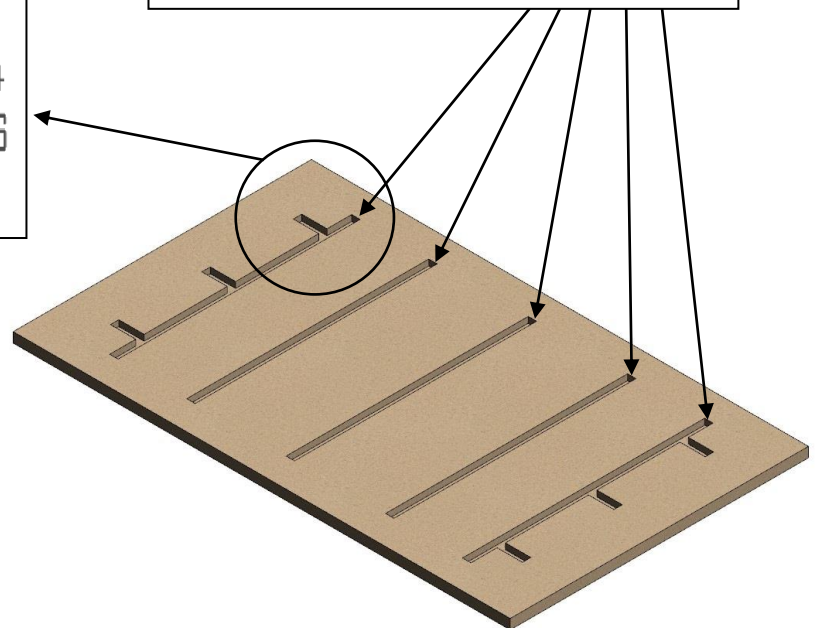
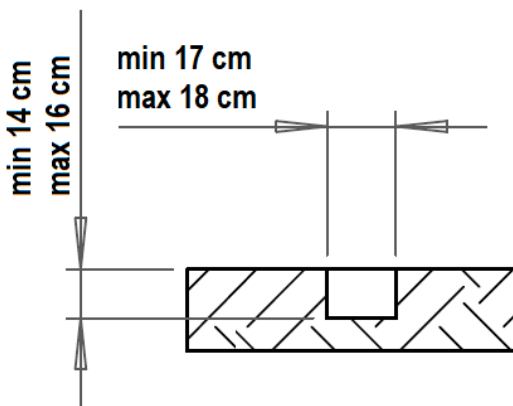

PL Podłoże

GB Ground

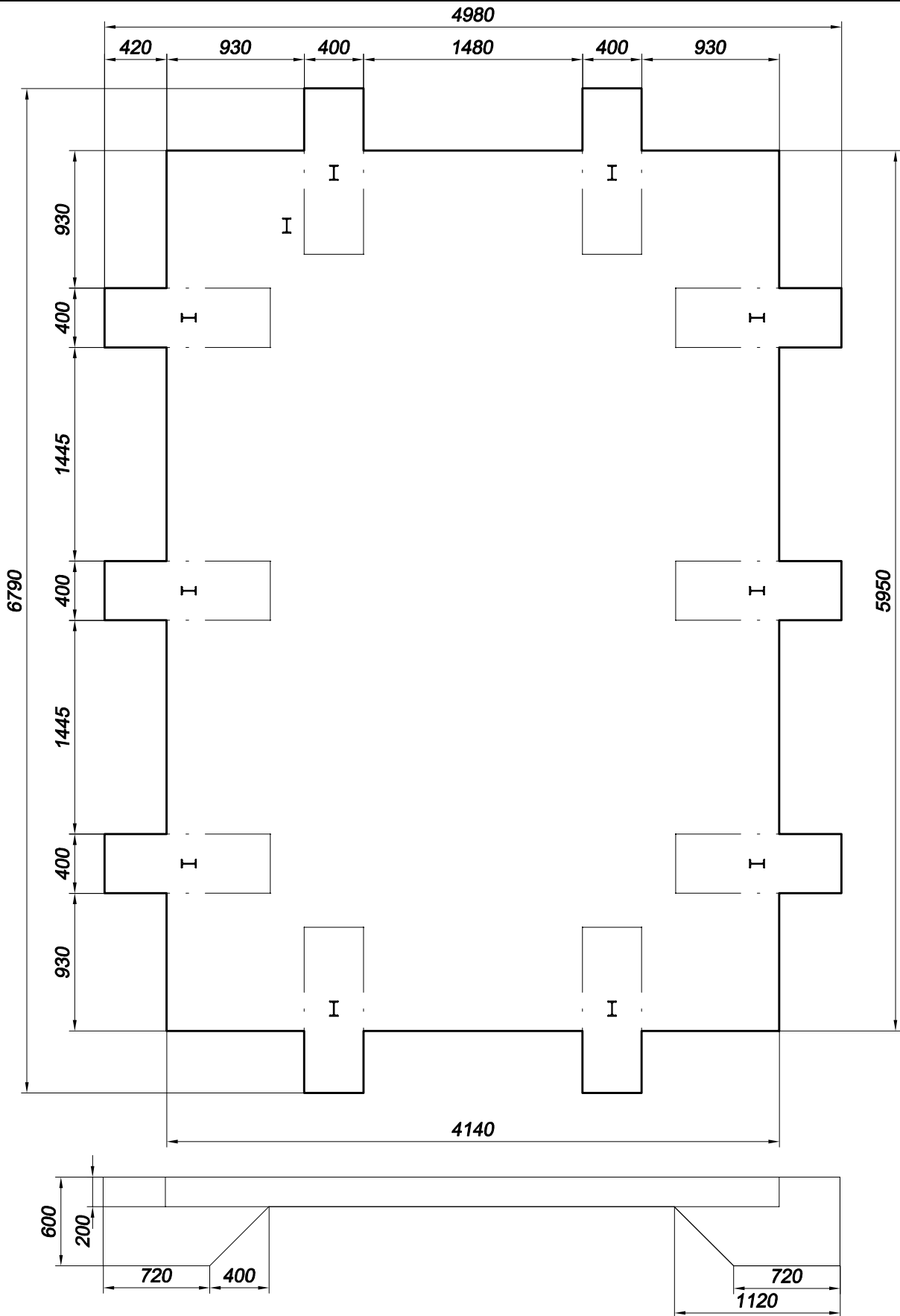

PL Podłoże

GB Ground

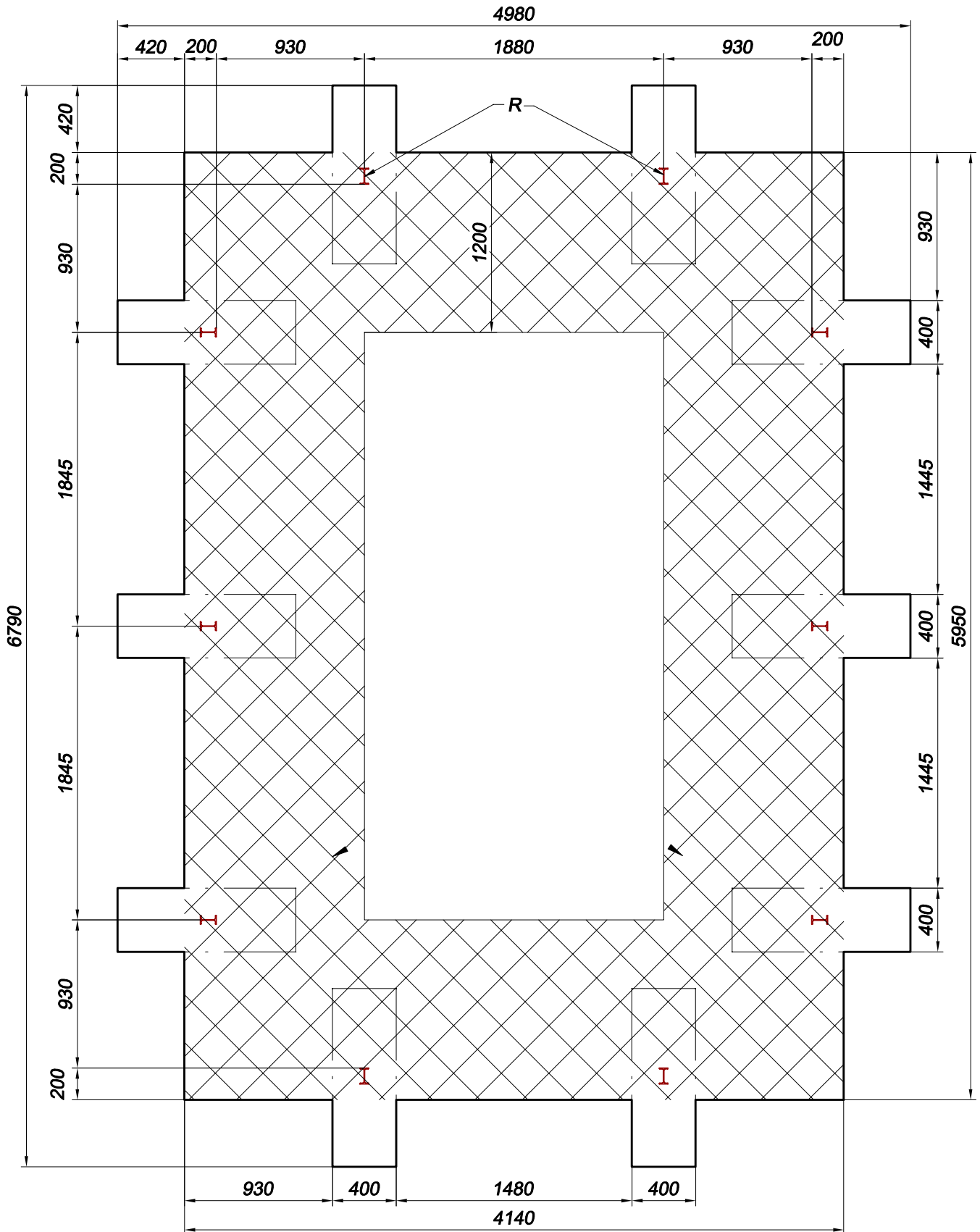

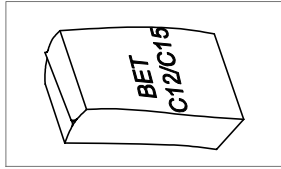

A-IIIIN (B500SP) Q188

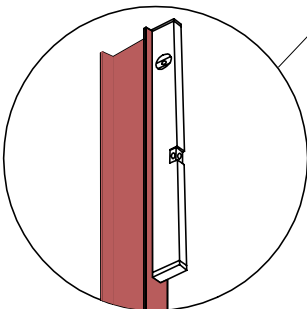
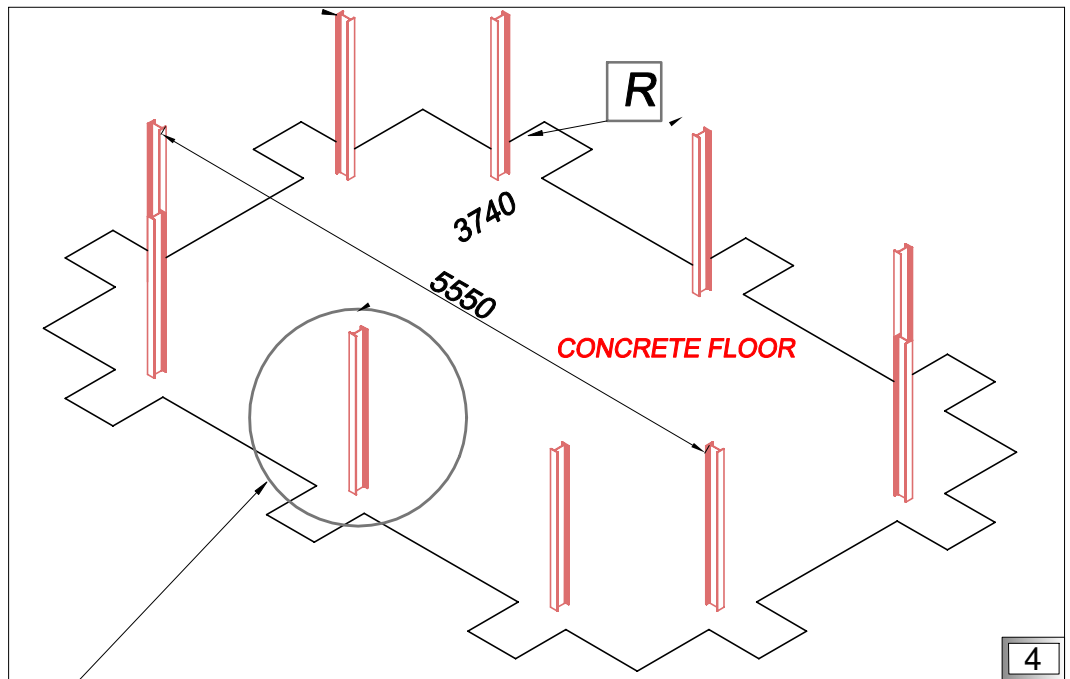
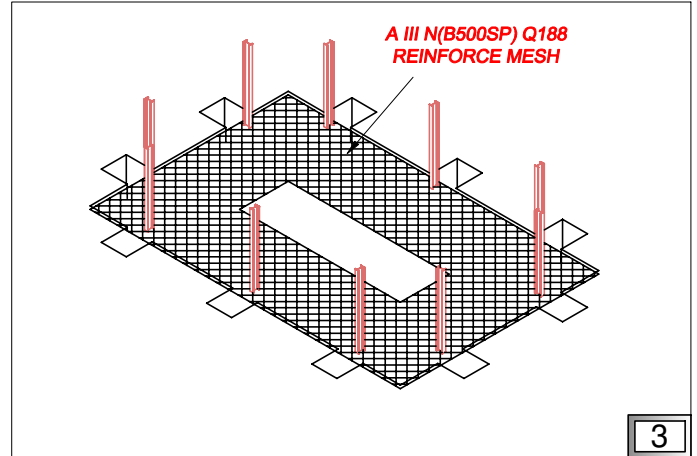
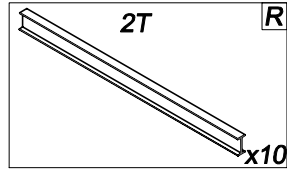
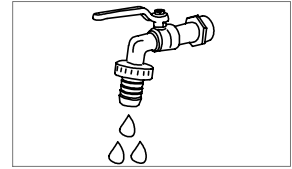
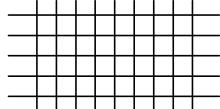

PL Podłoże

GB Ground

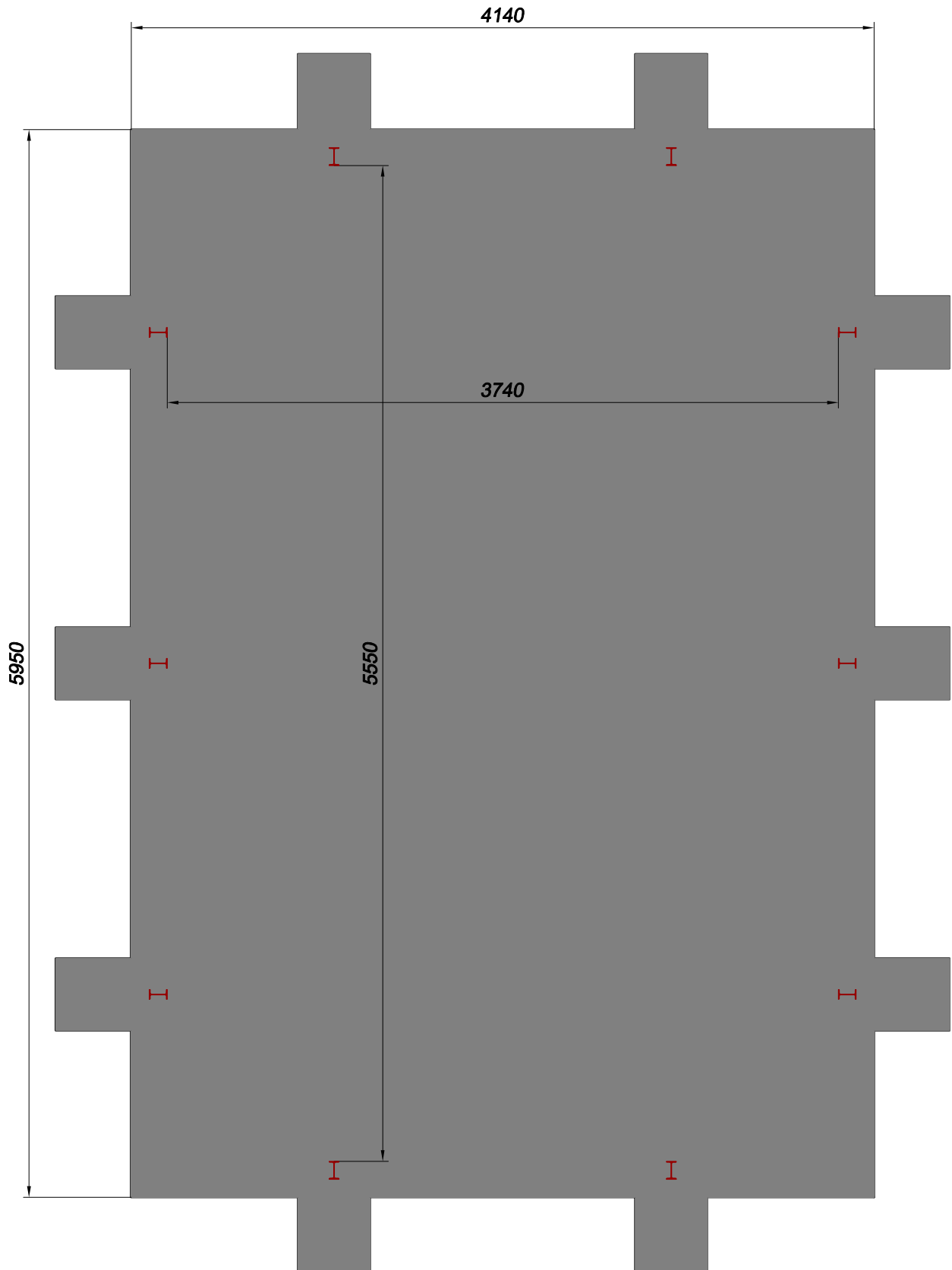



1

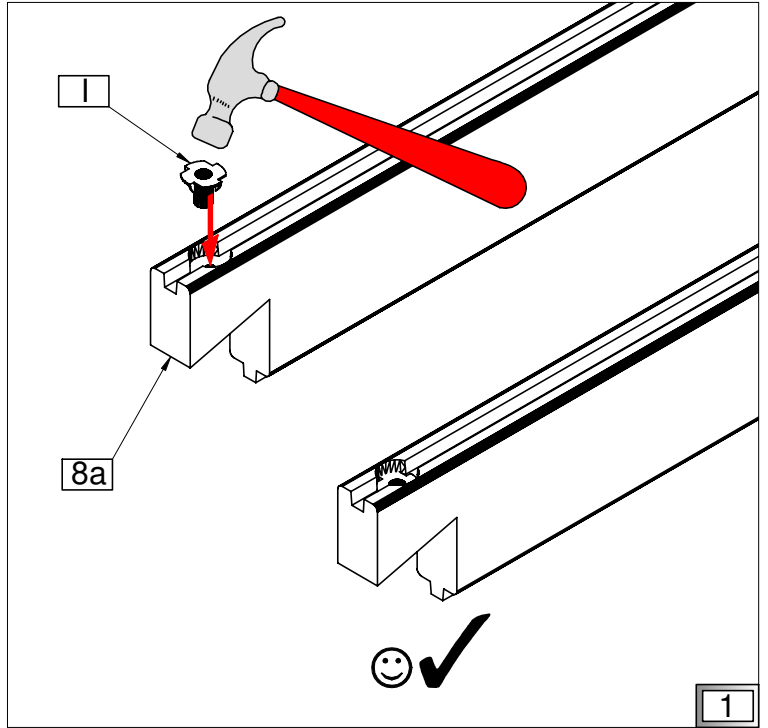
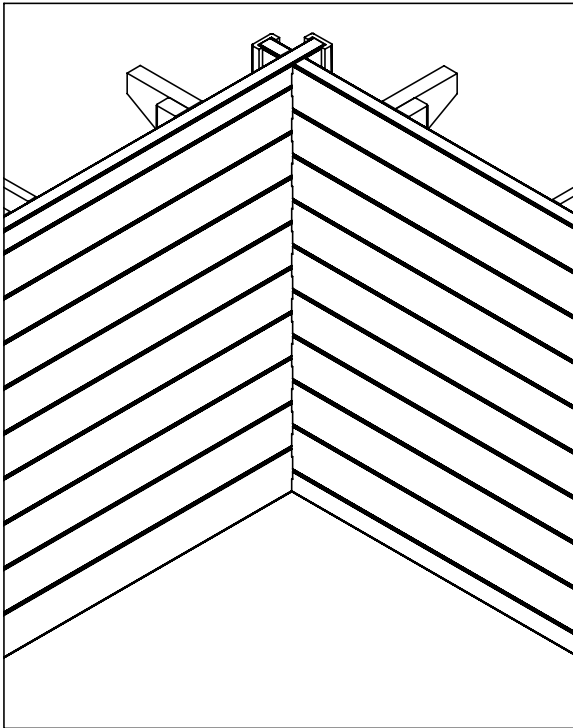
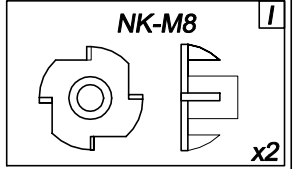
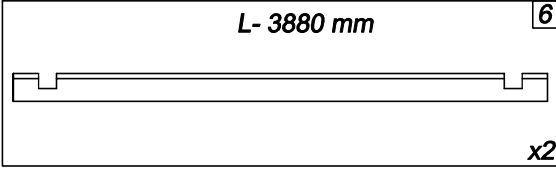
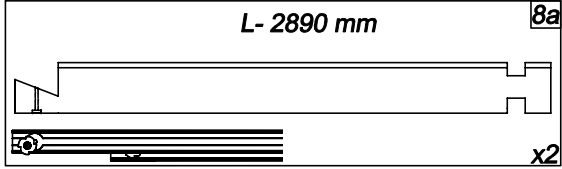

1

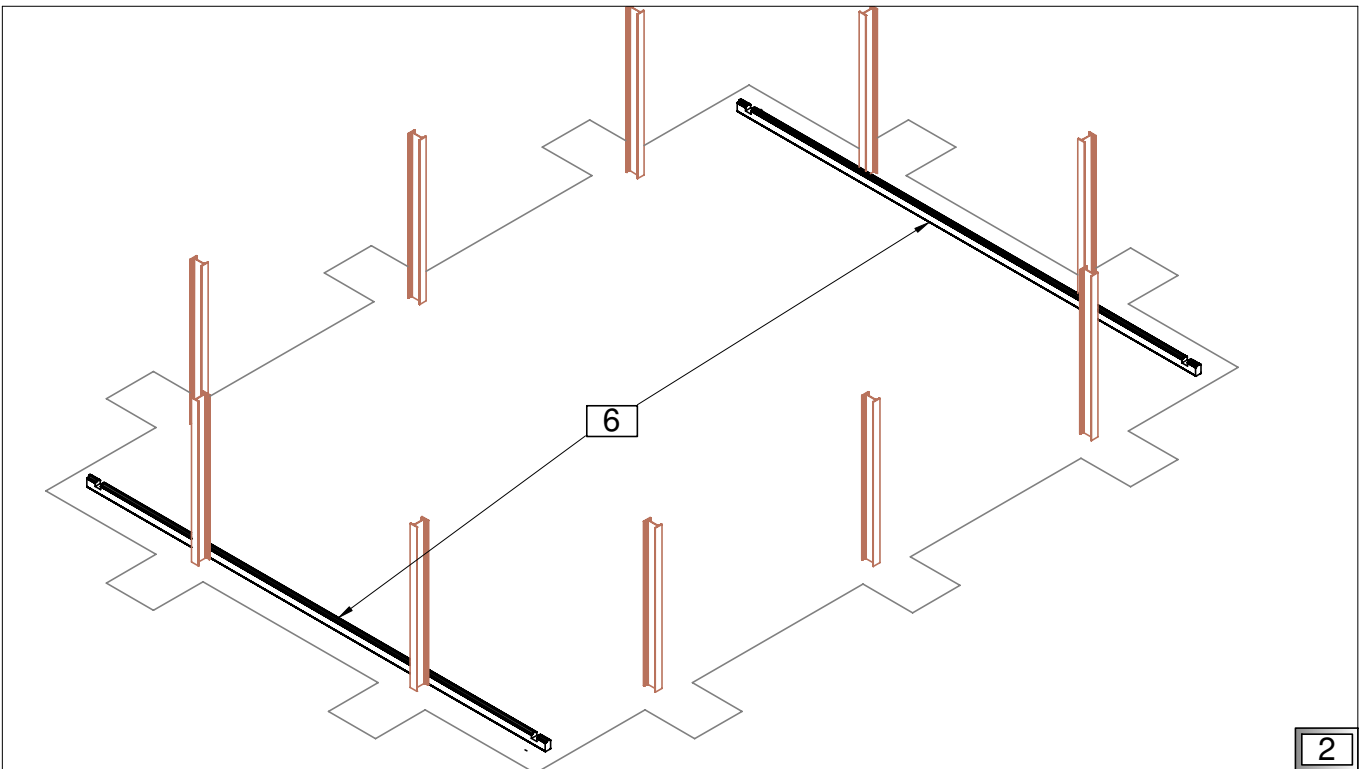

2



1

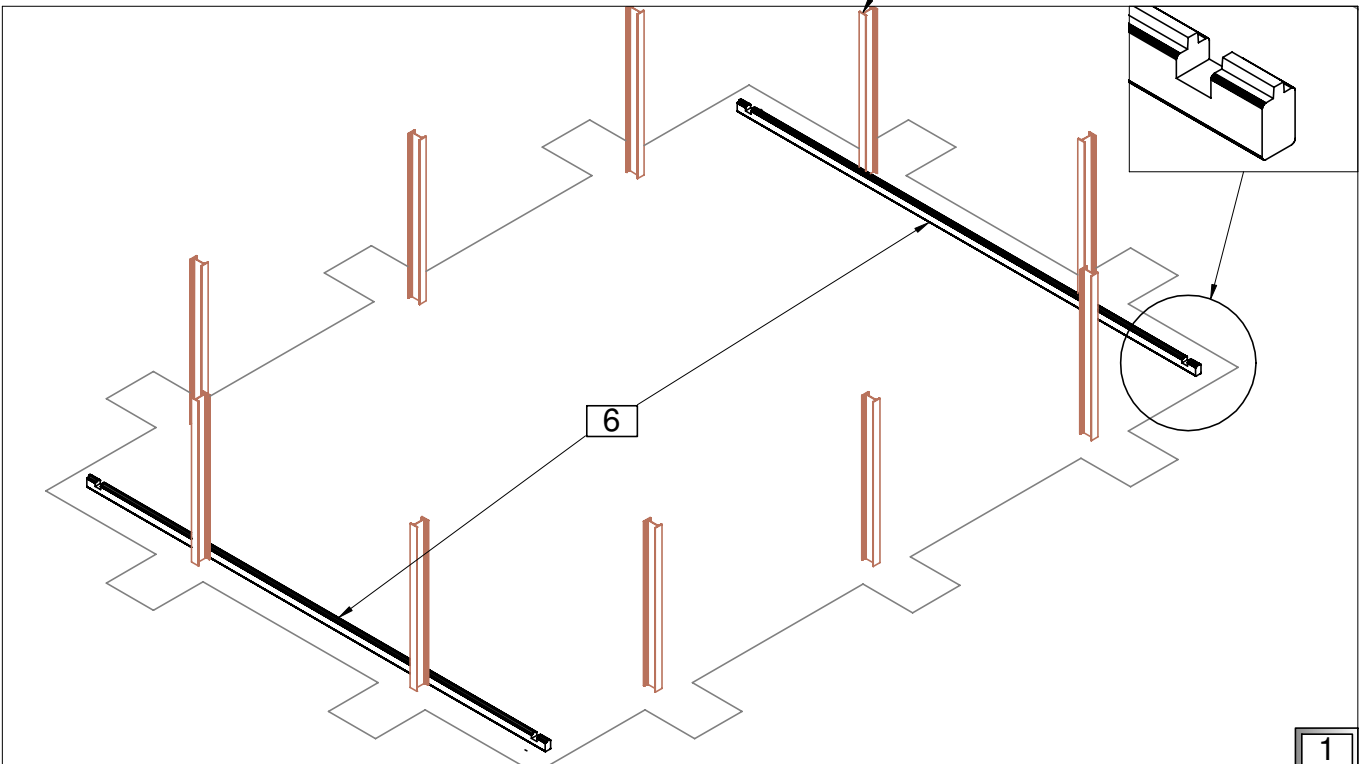
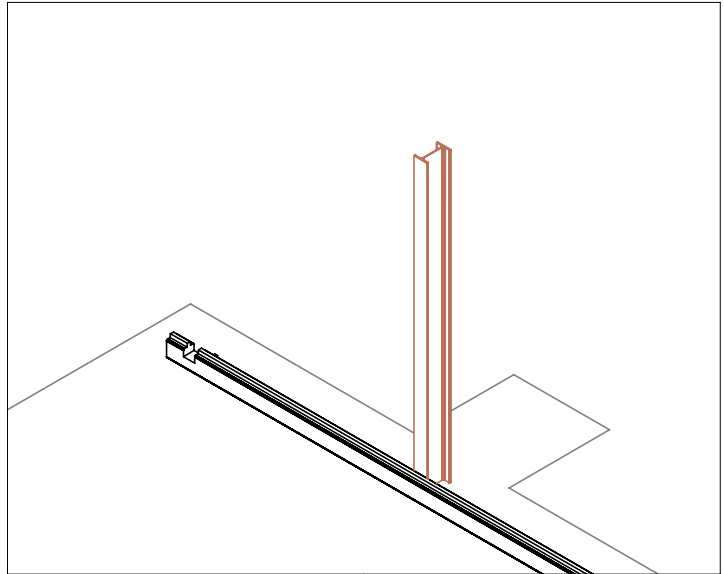
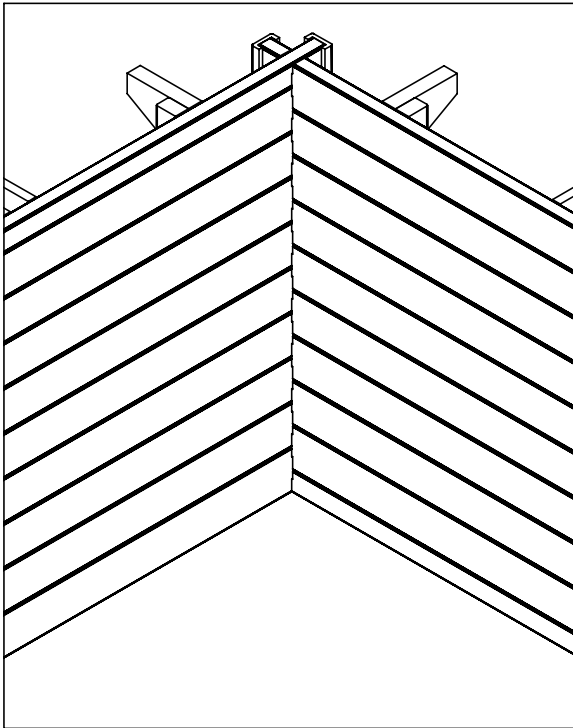
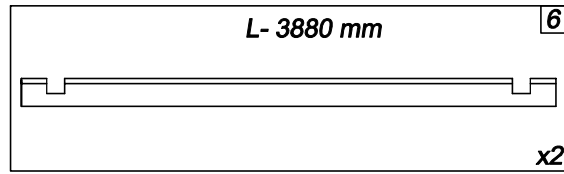



I

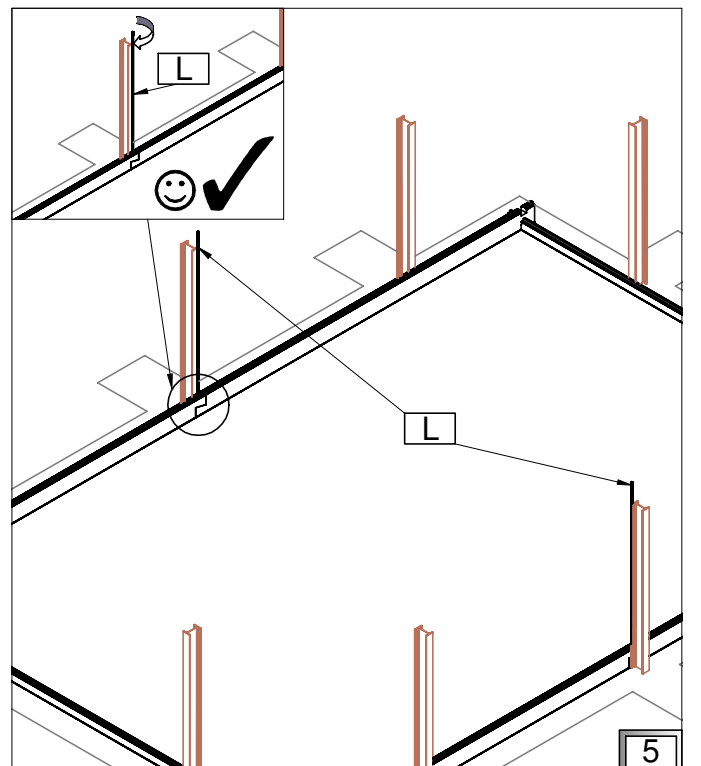
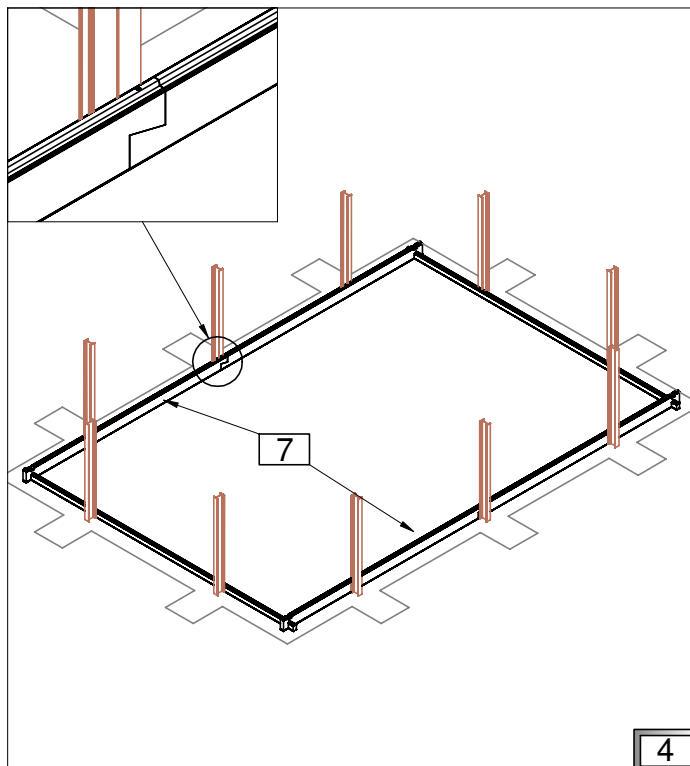
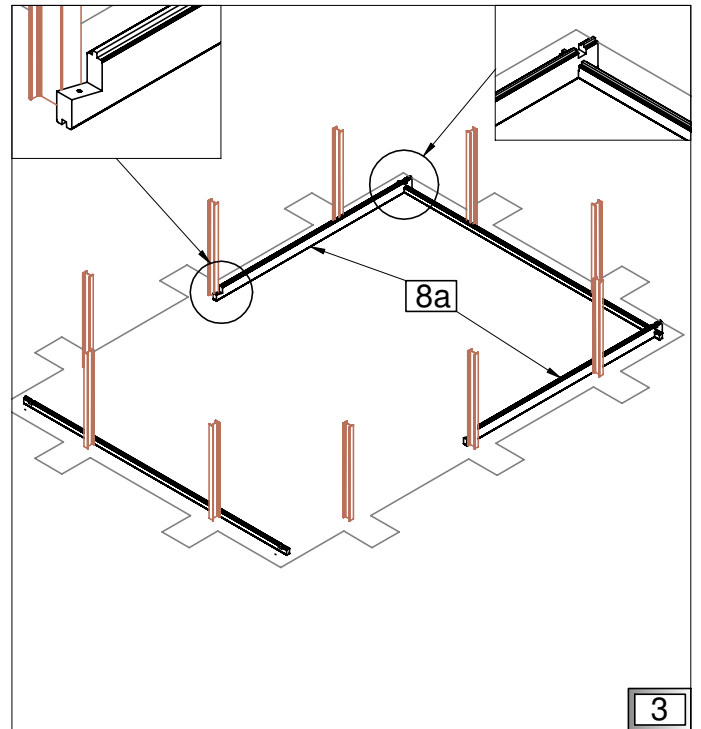
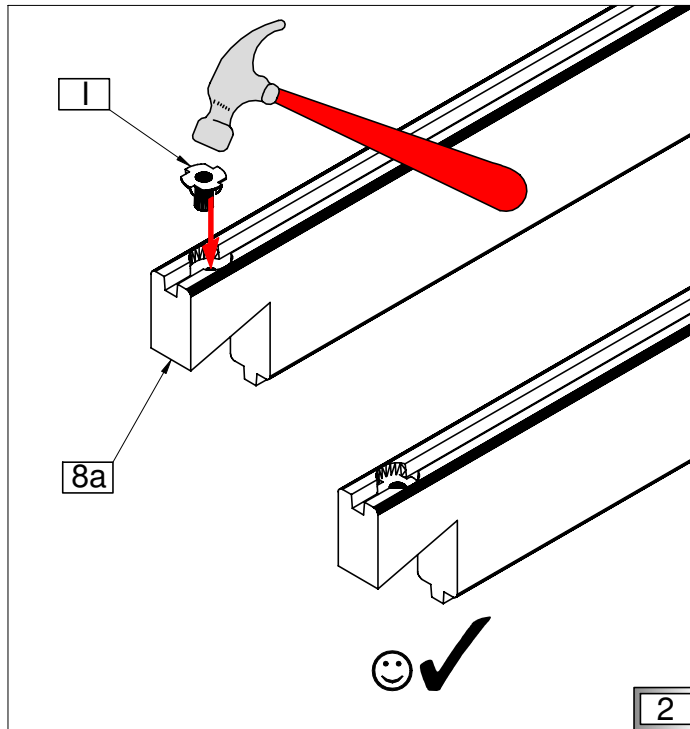
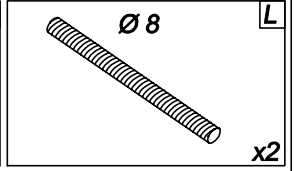
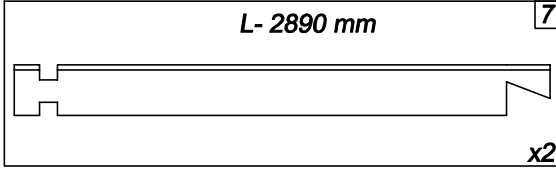
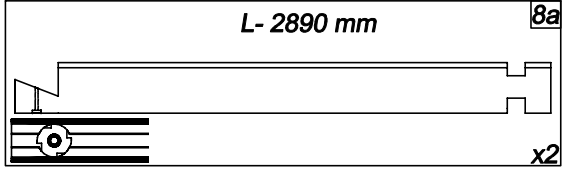

PL Struktura drewniana

GB Wooden structure

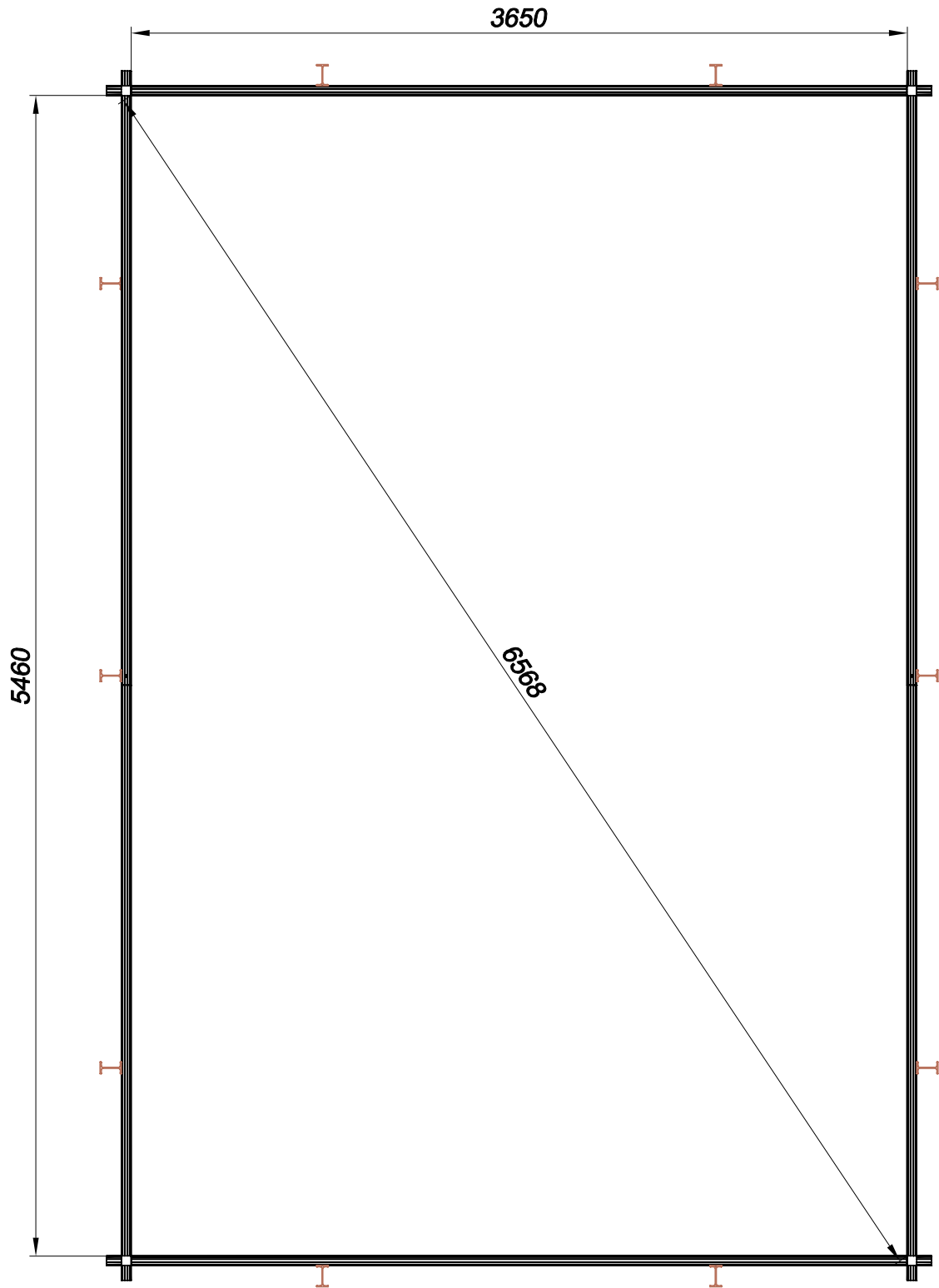

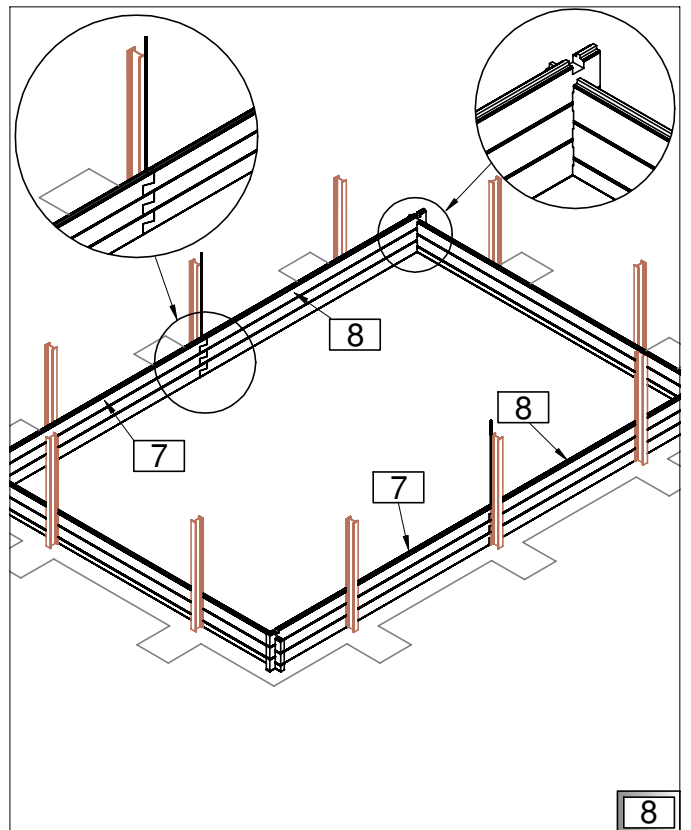
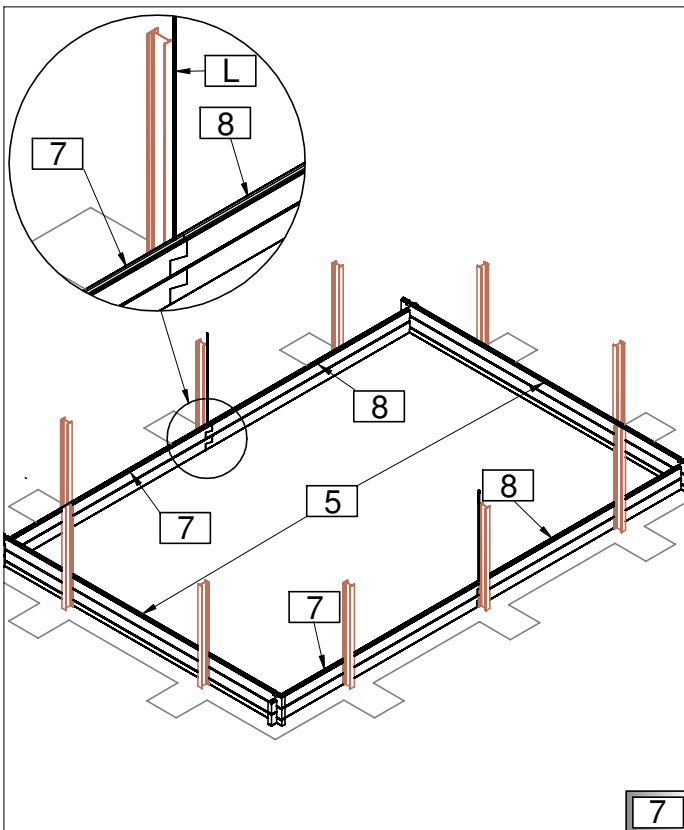
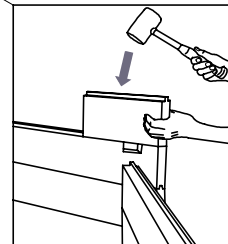
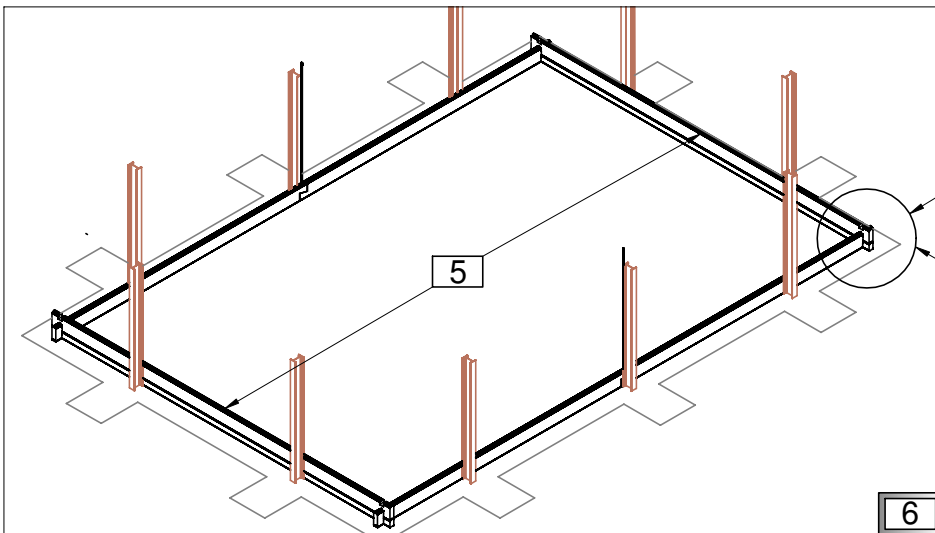
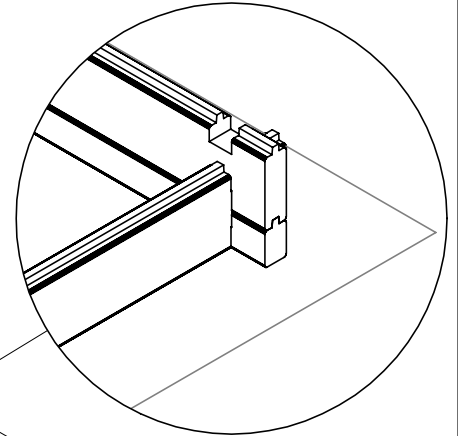
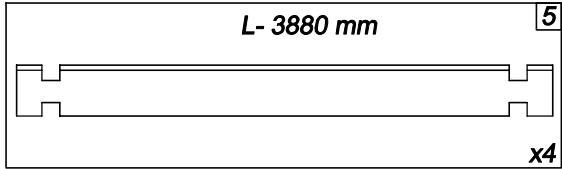
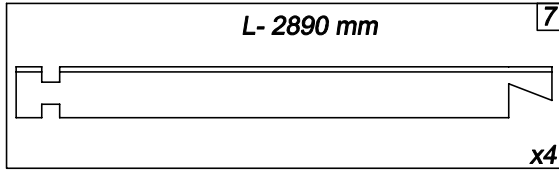
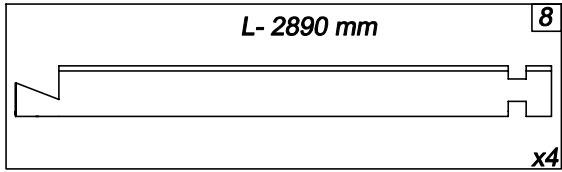

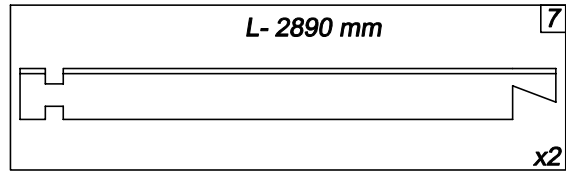
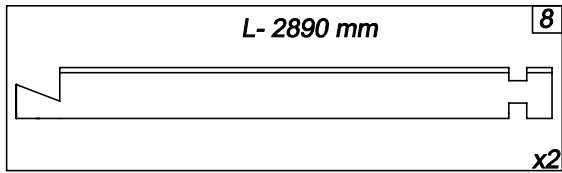

IV

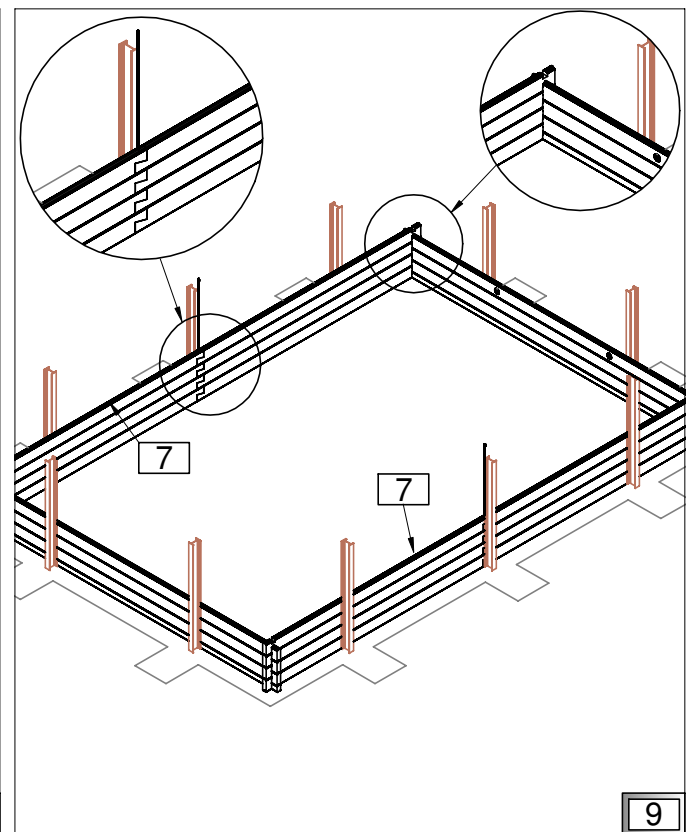
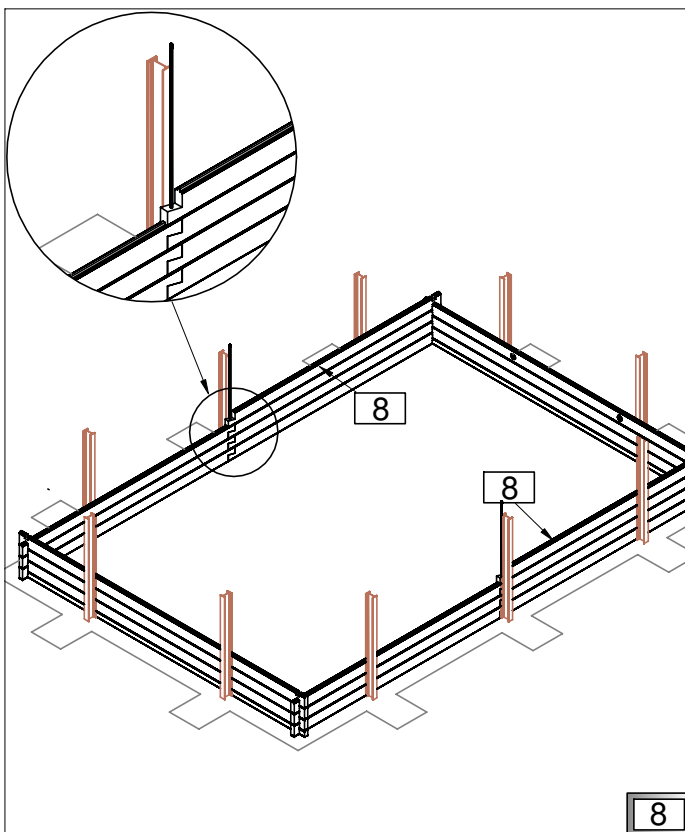
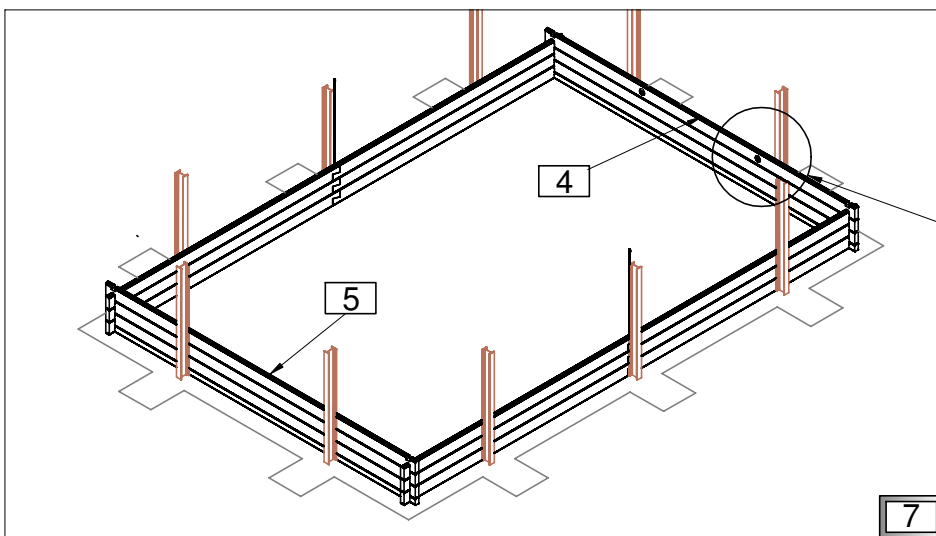
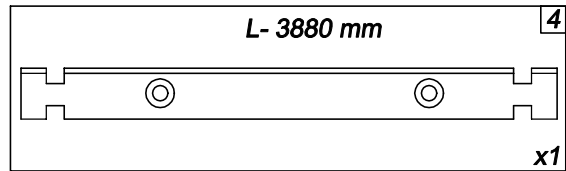
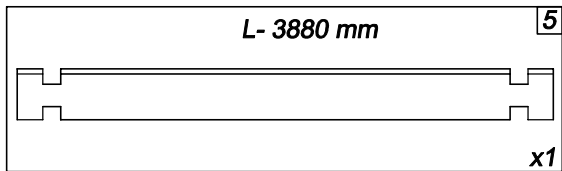

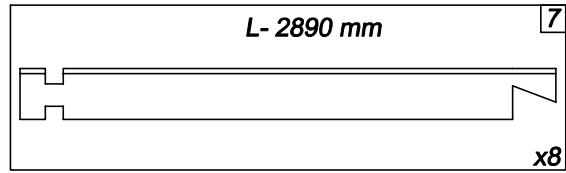
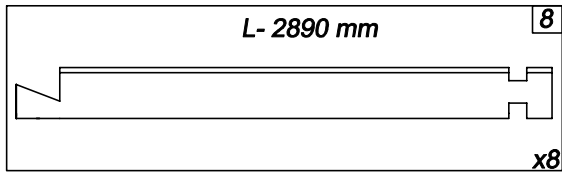

V-VIII

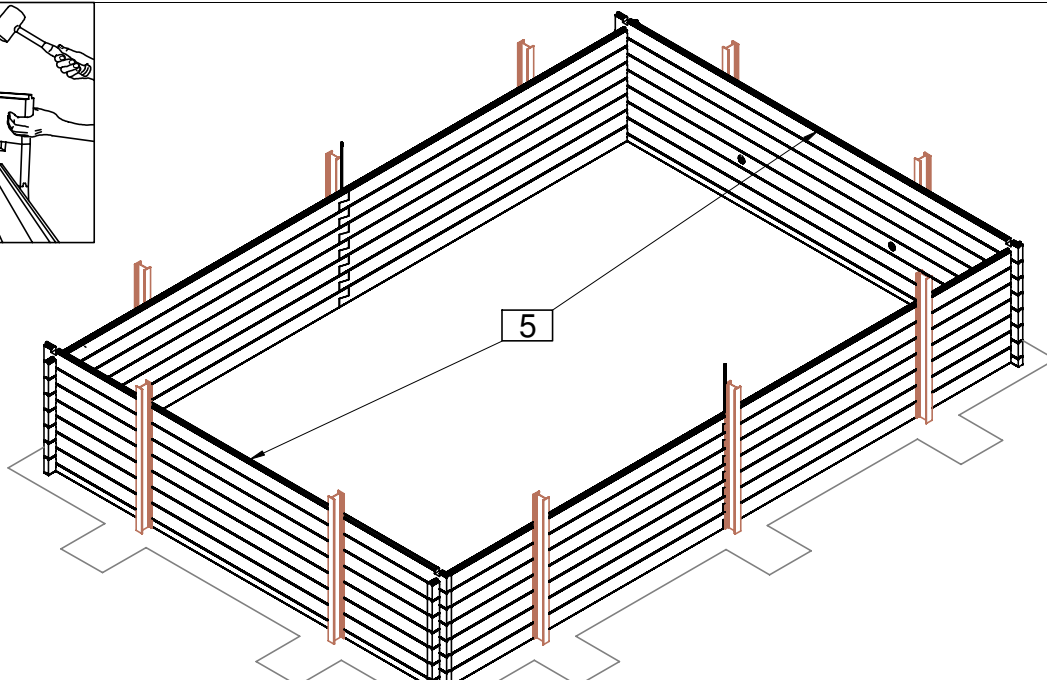
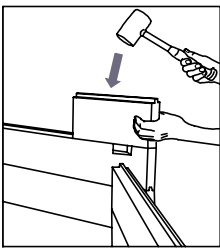
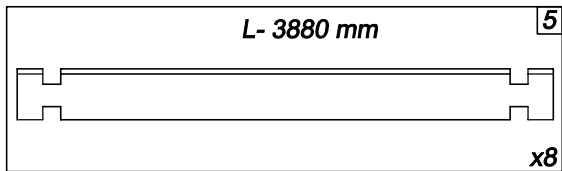

10

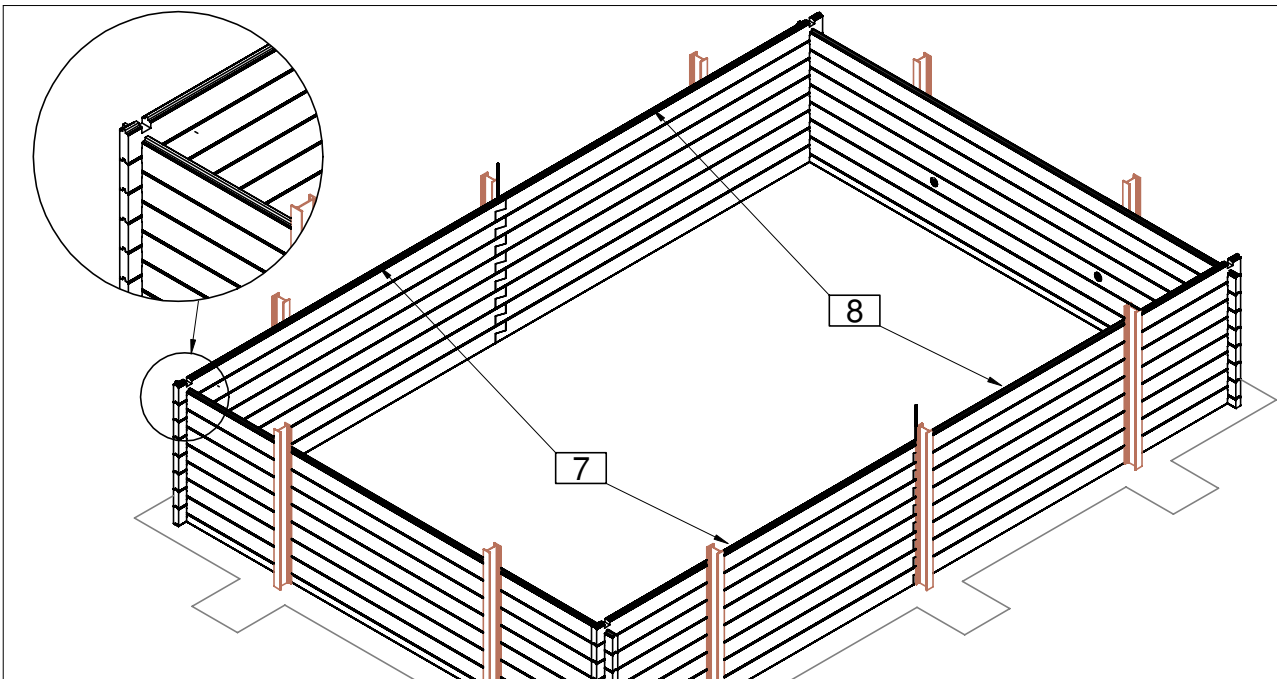

11

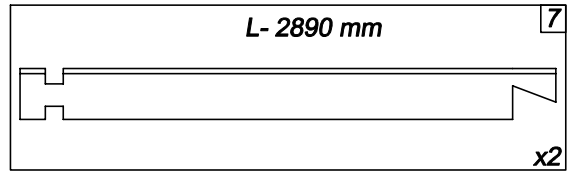
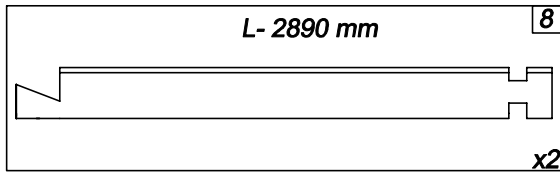

IX

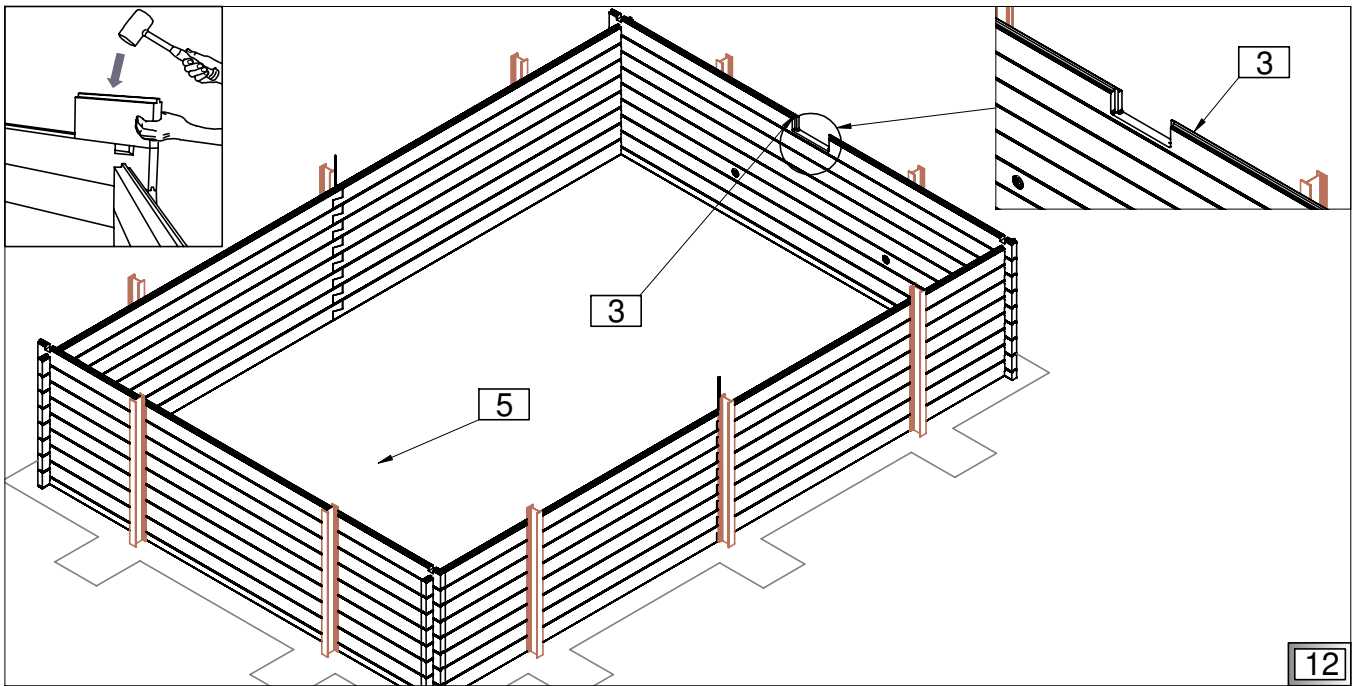
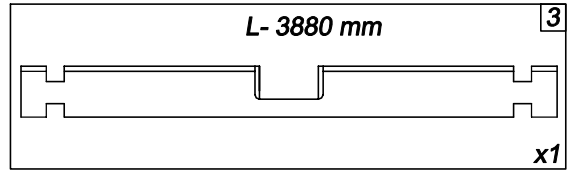
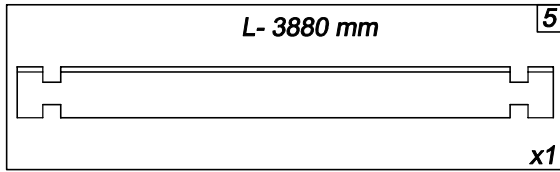

12

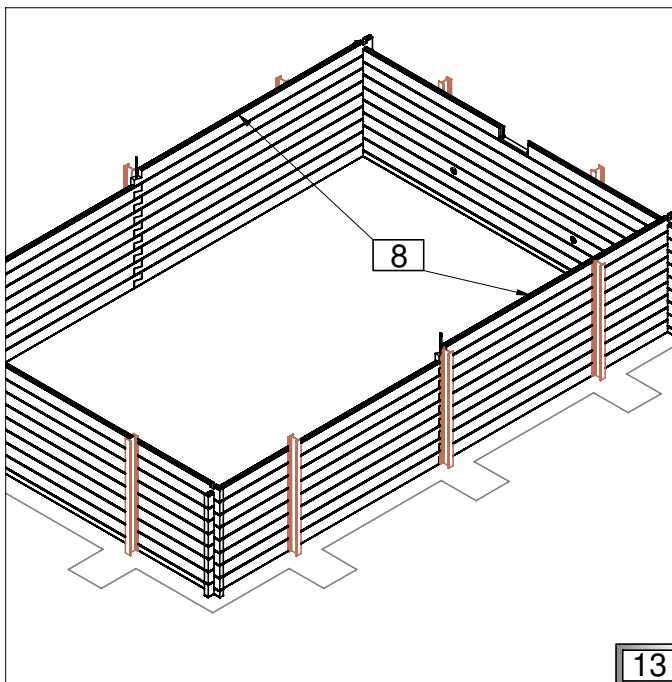

13

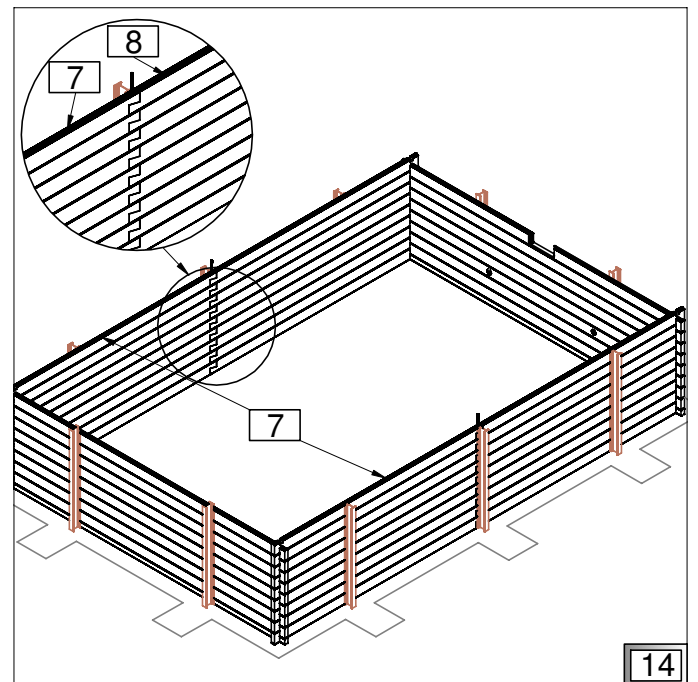

14

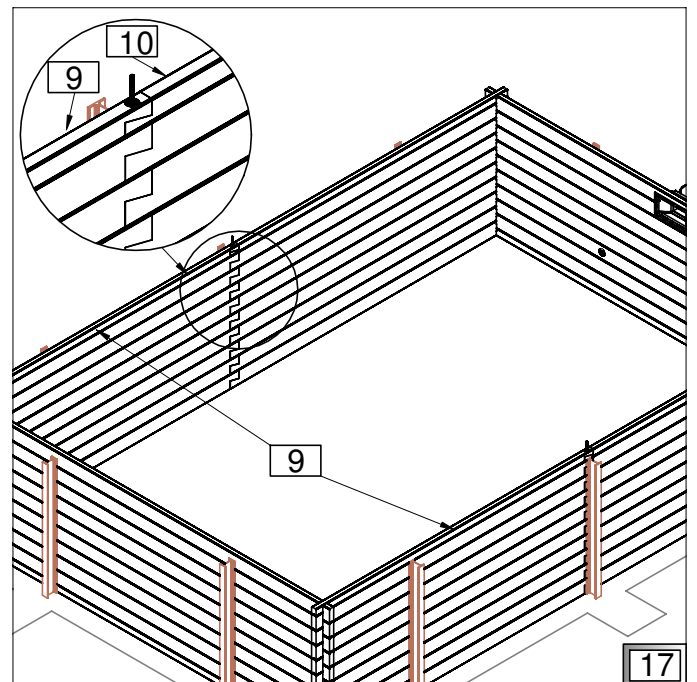
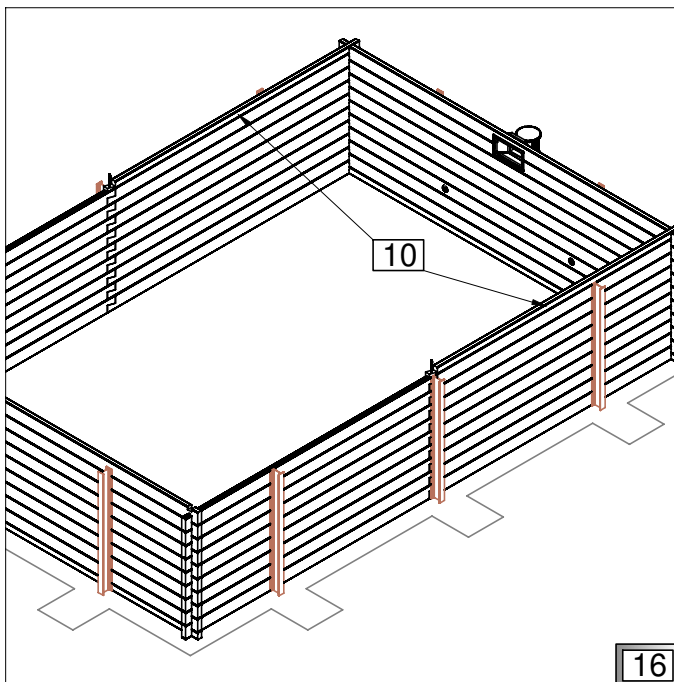
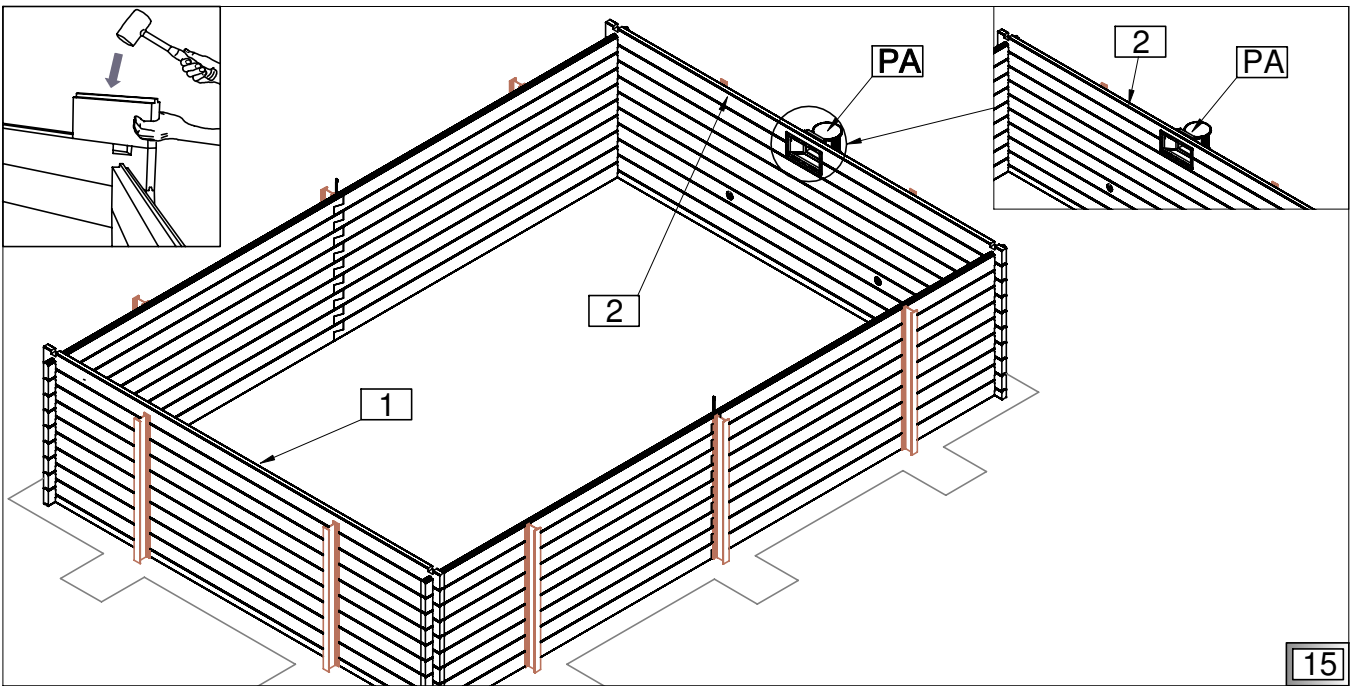
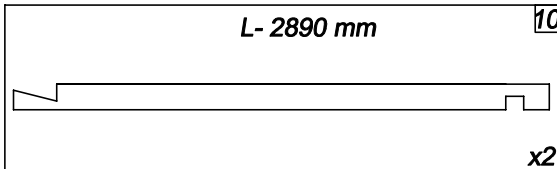
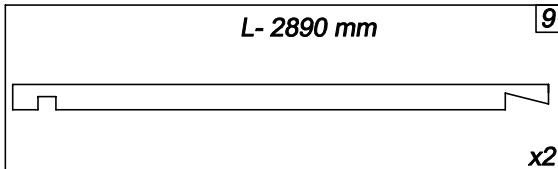
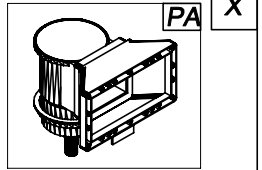
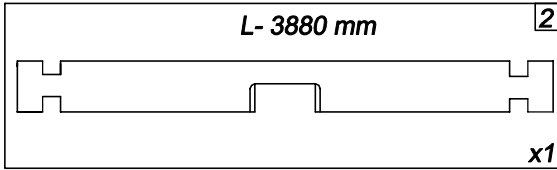
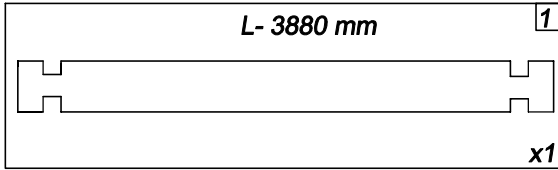

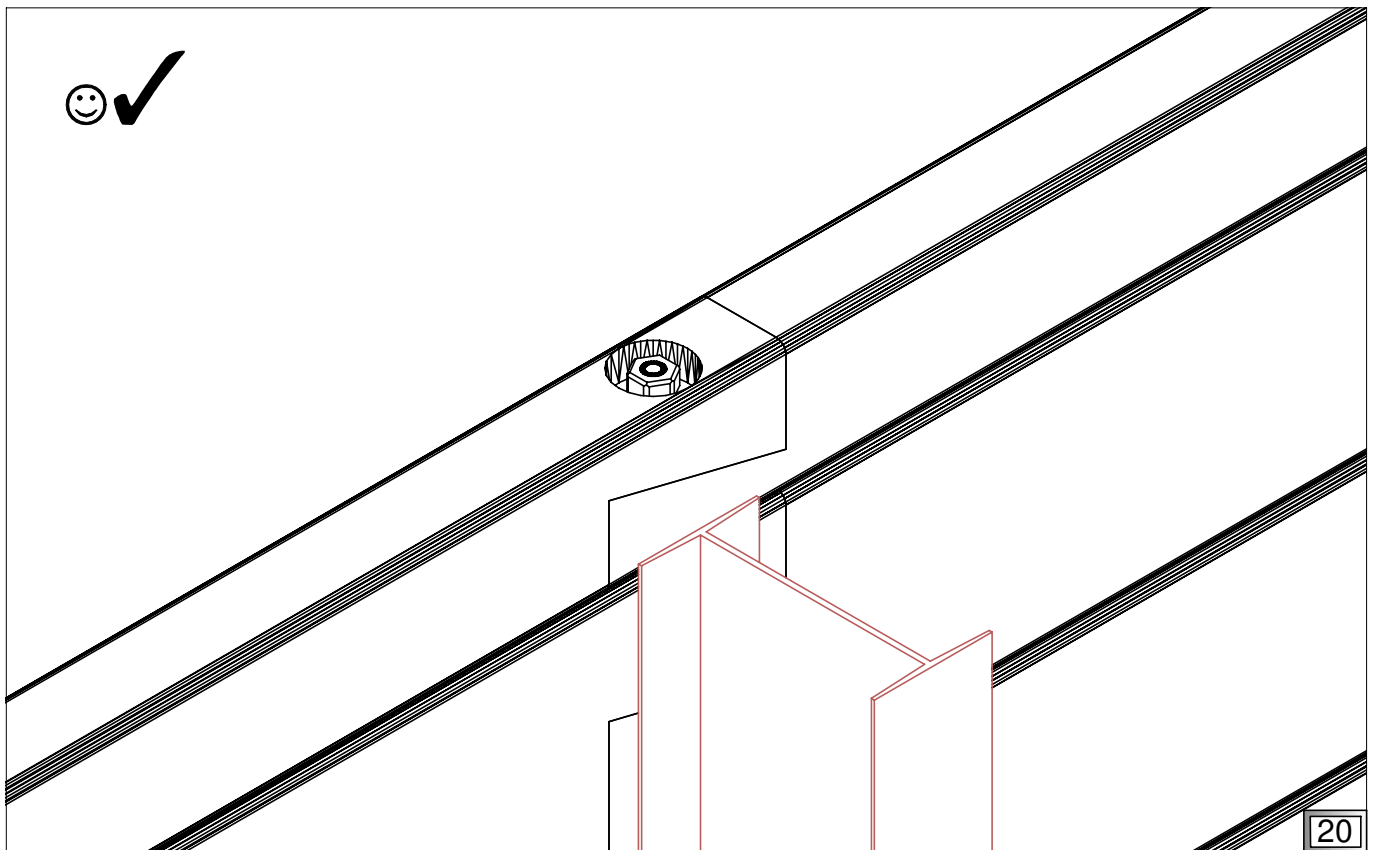
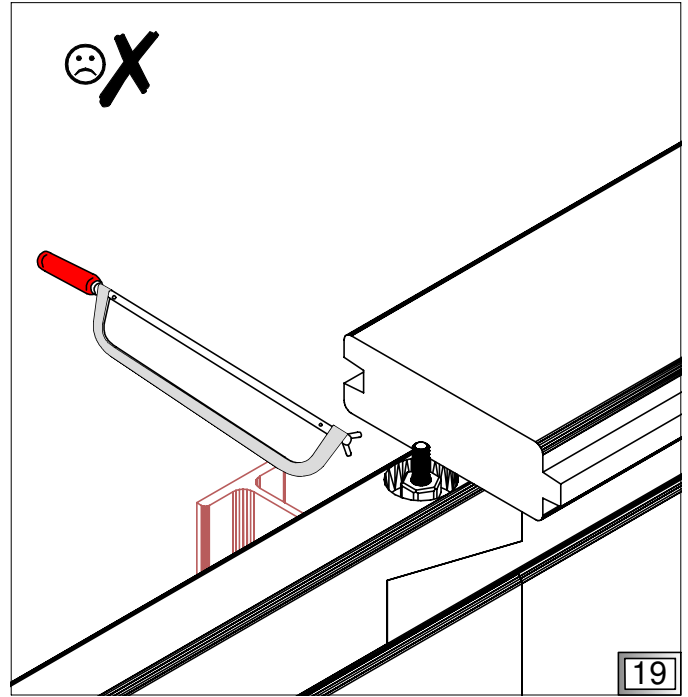
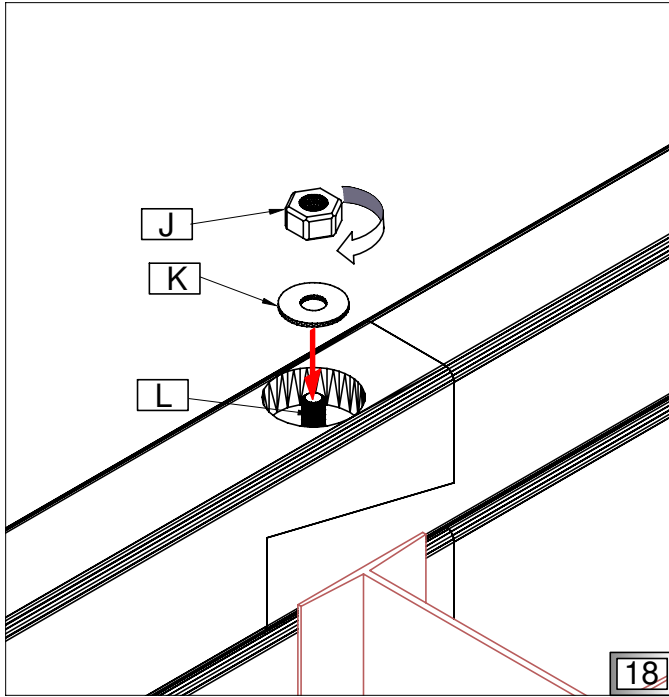
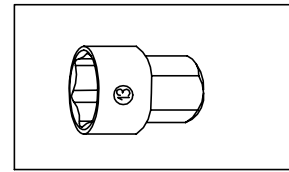
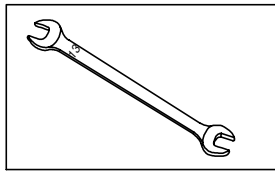
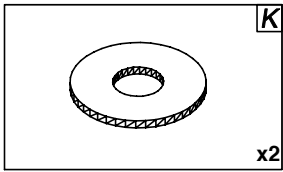
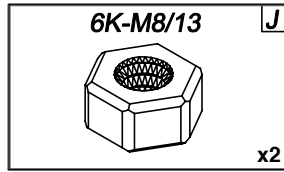

18

19

20

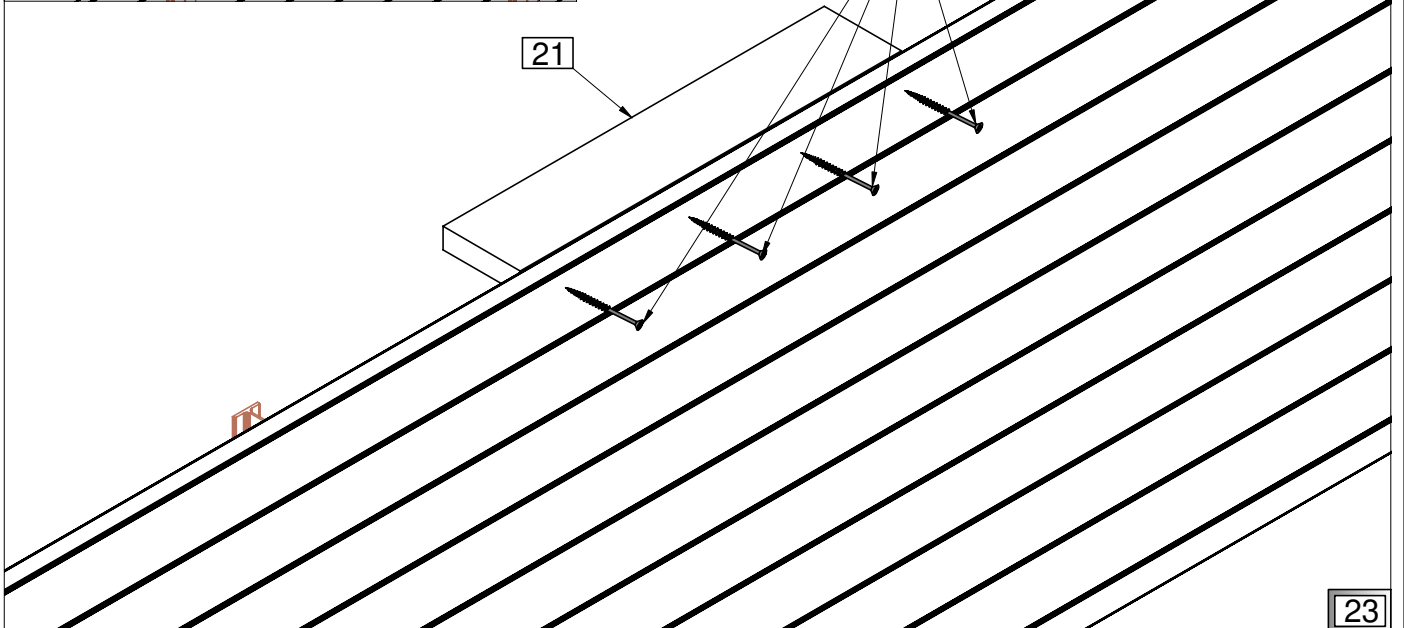
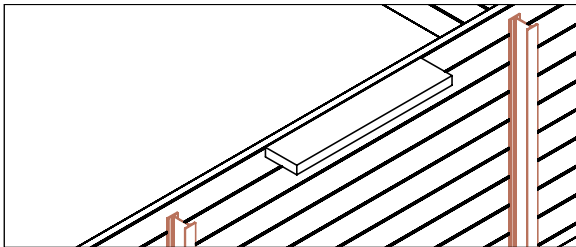
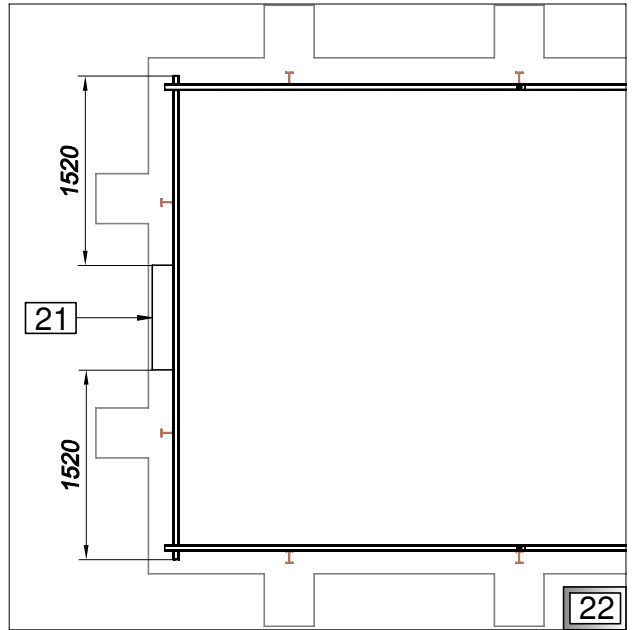
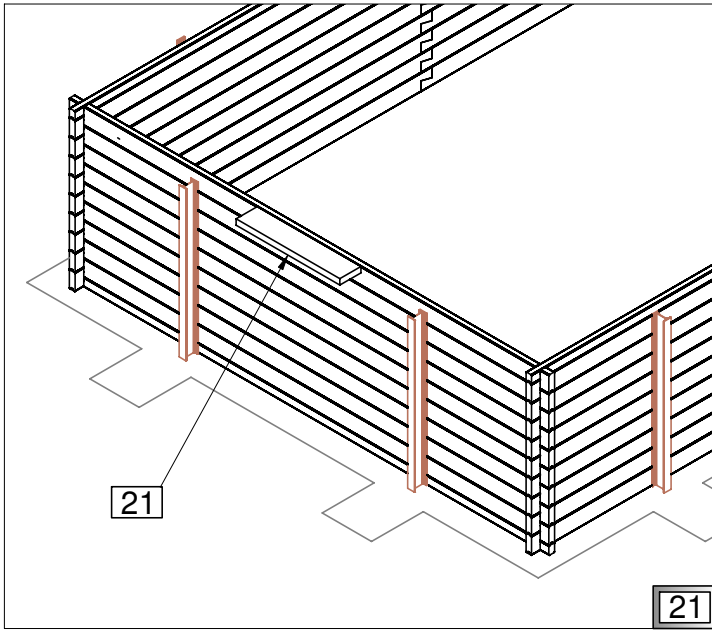
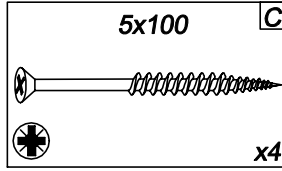
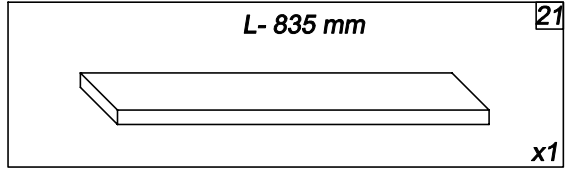

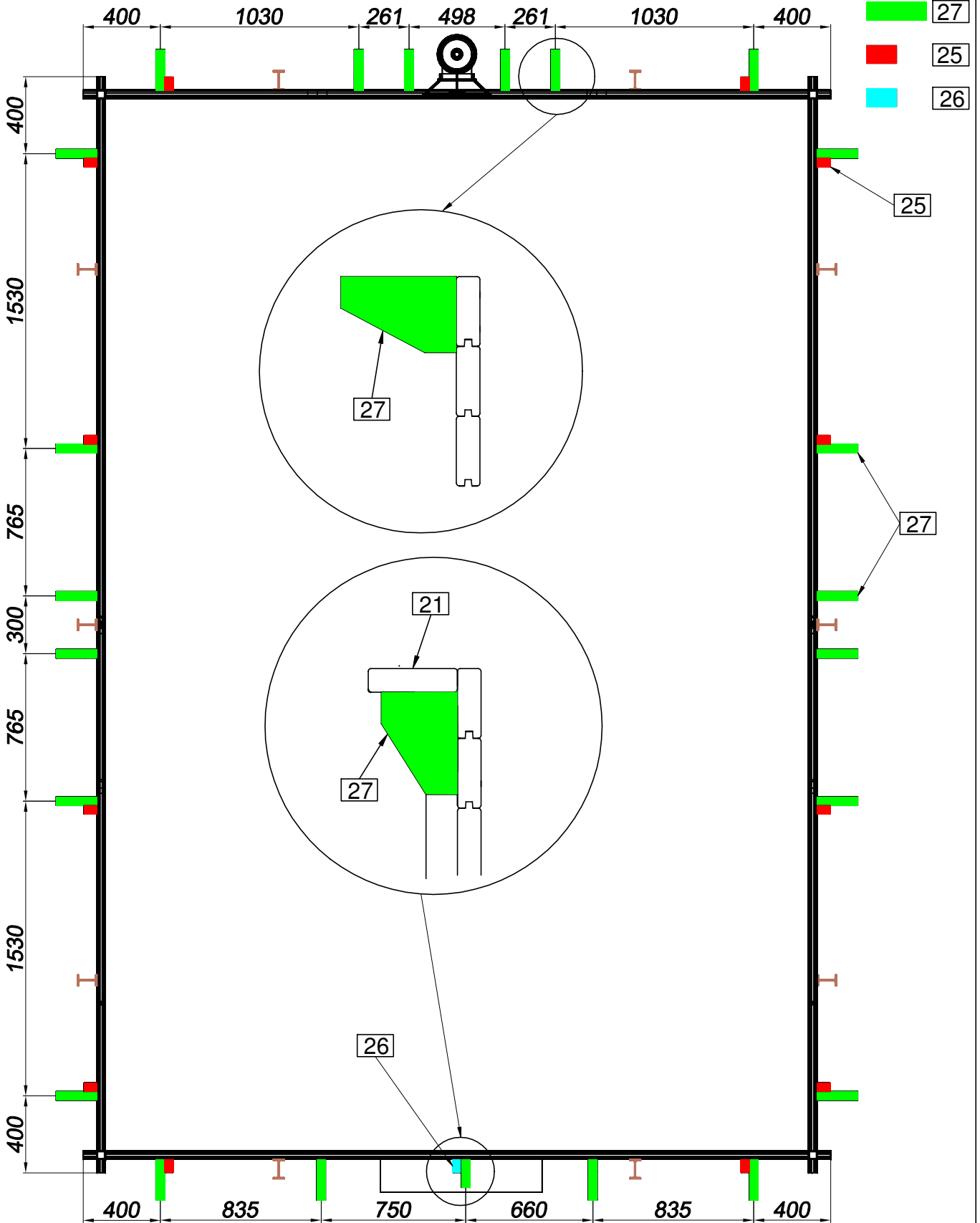

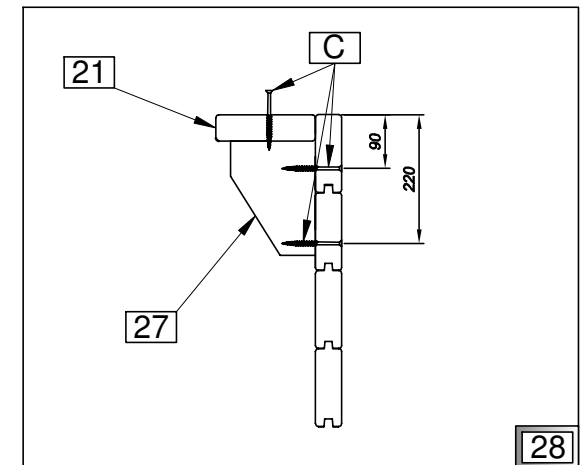
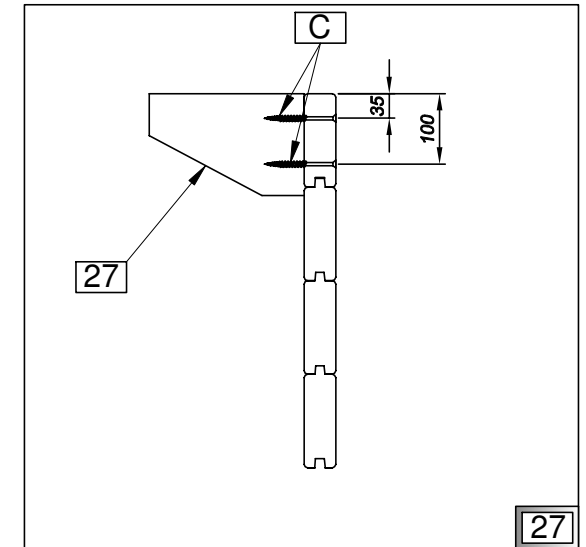
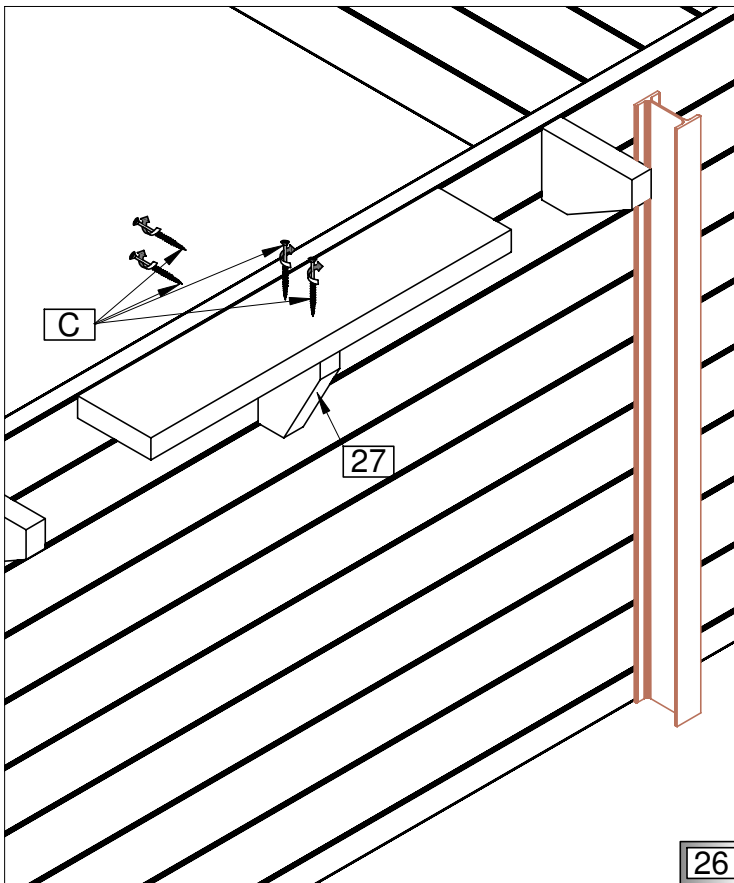
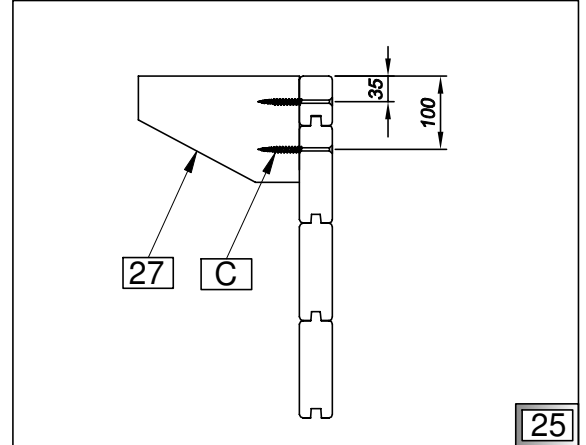
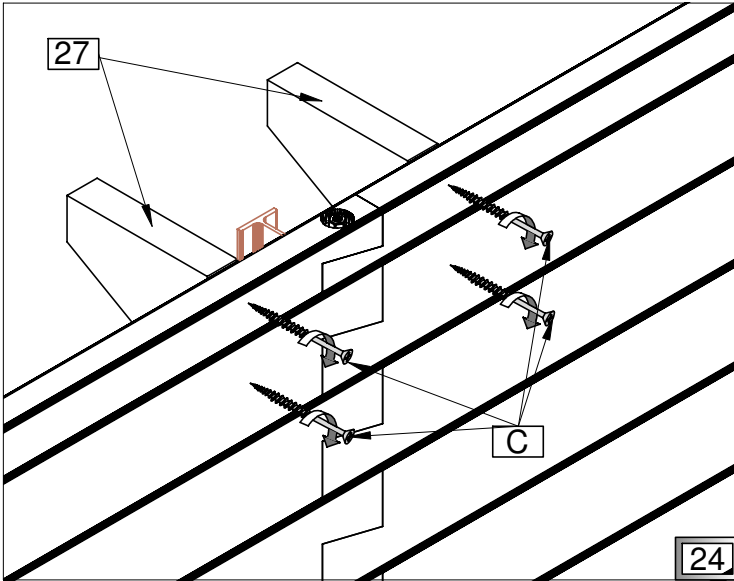
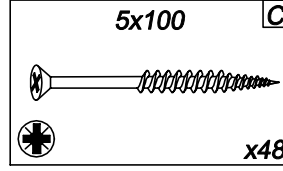
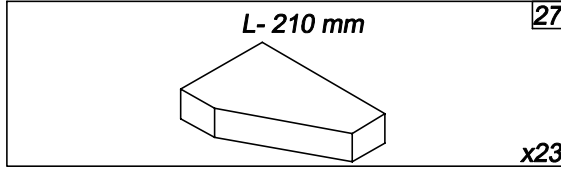

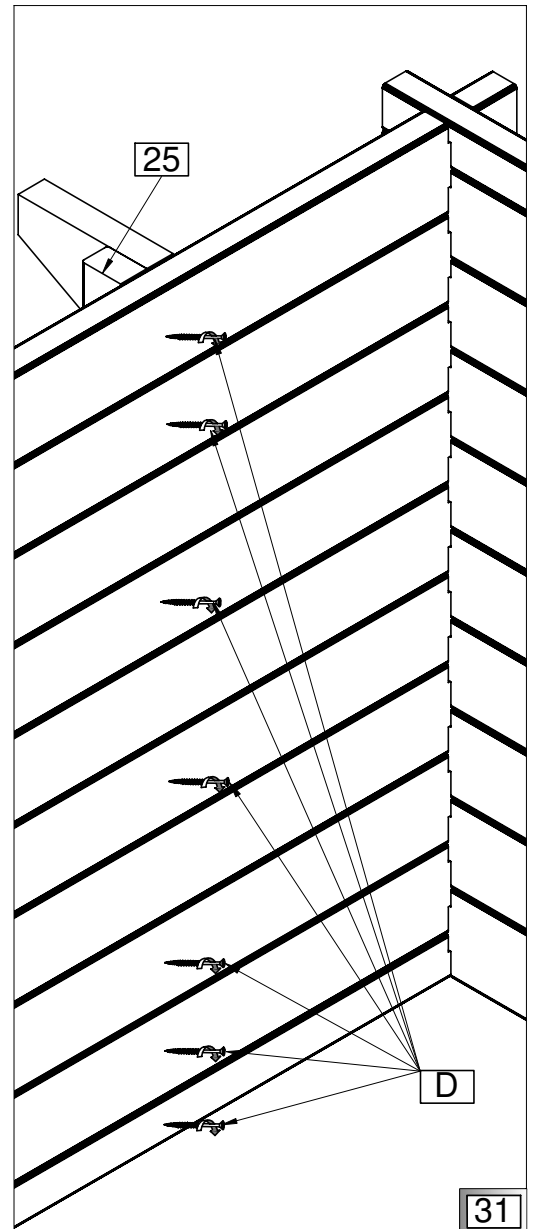
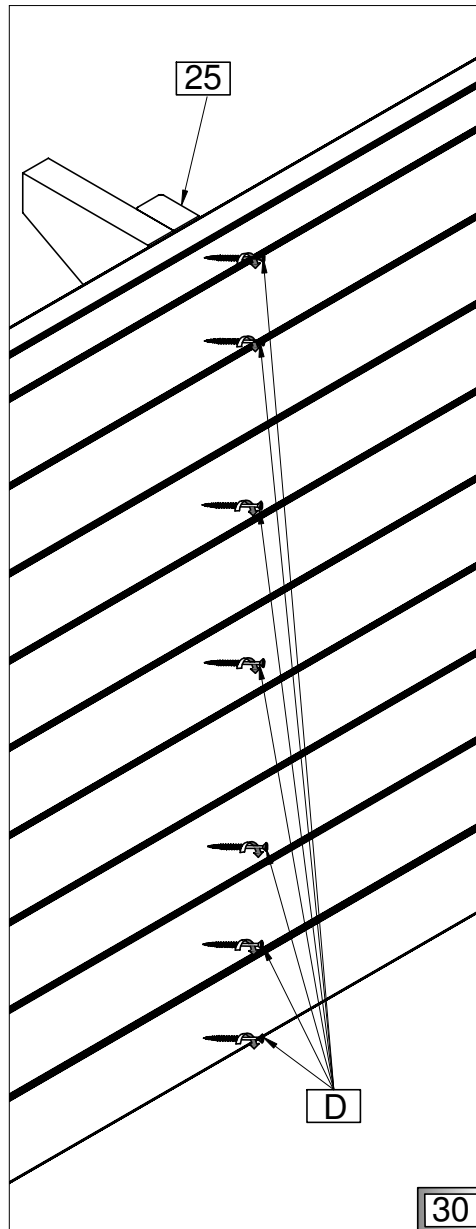
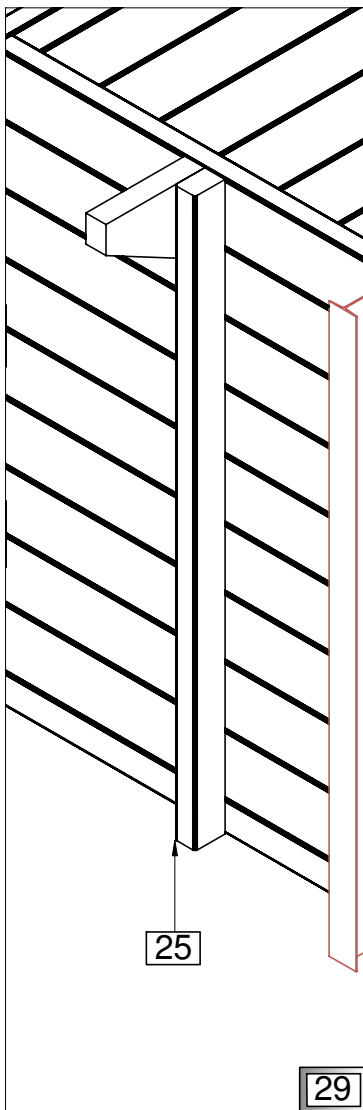
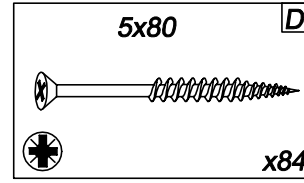
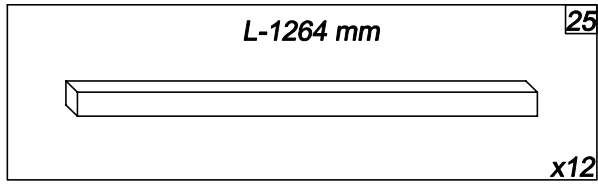

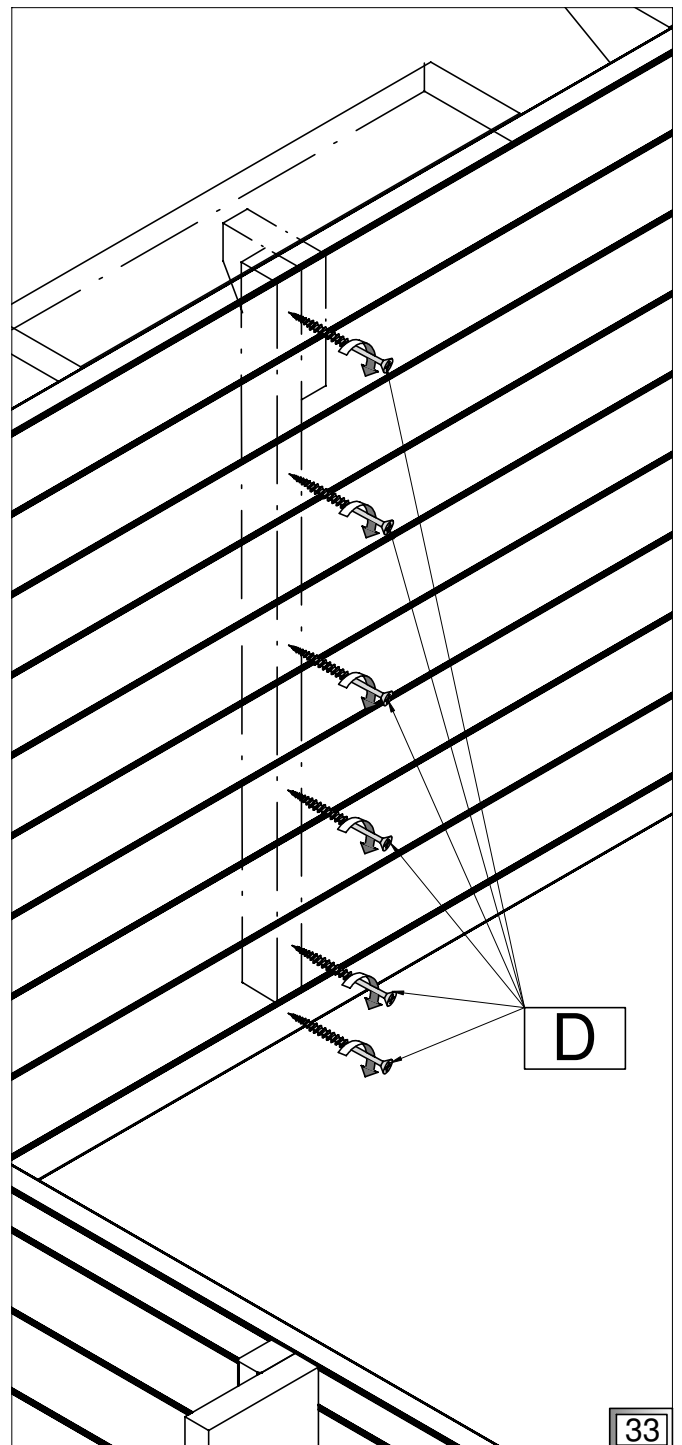
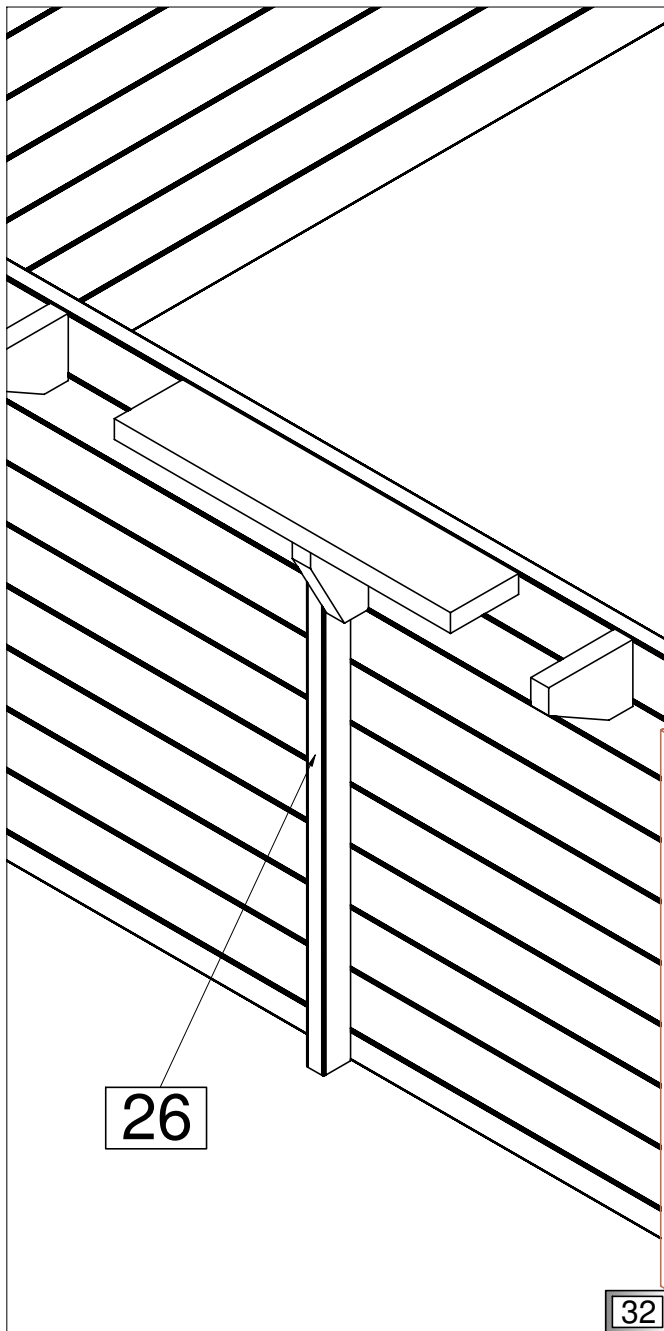
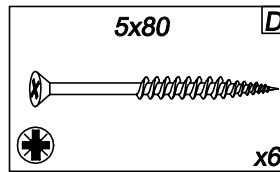
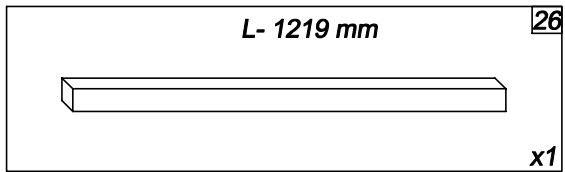

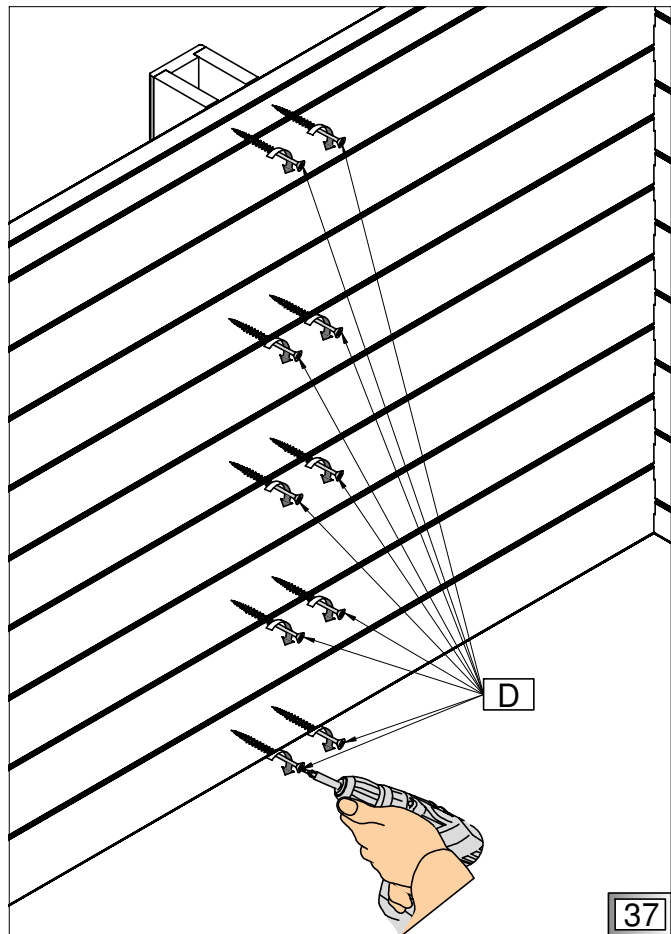
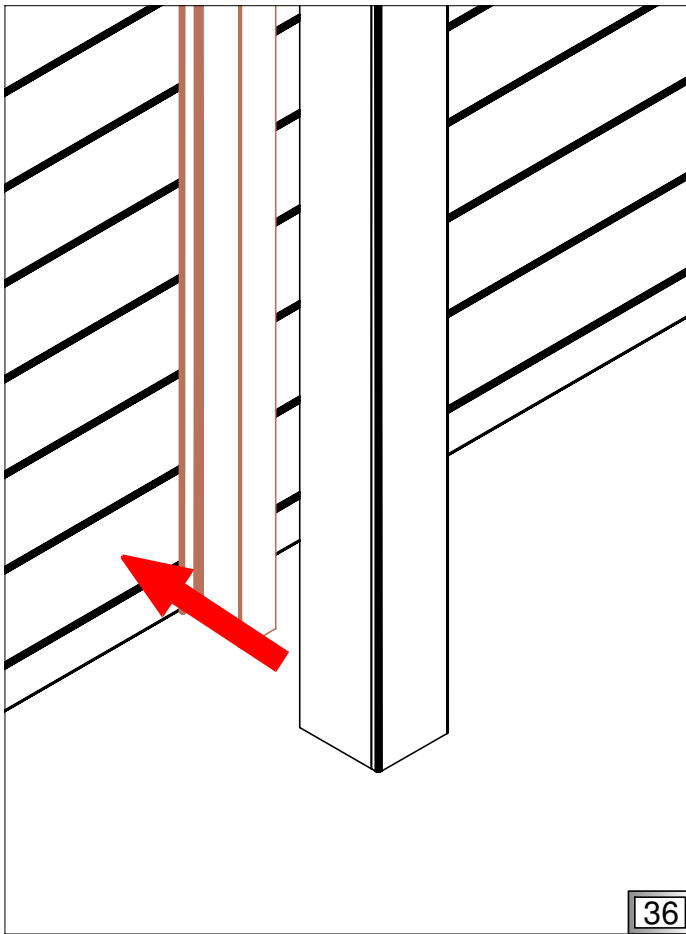
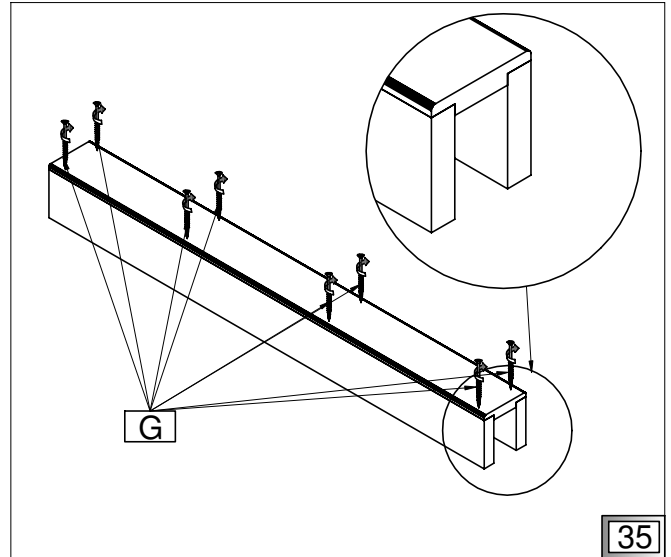
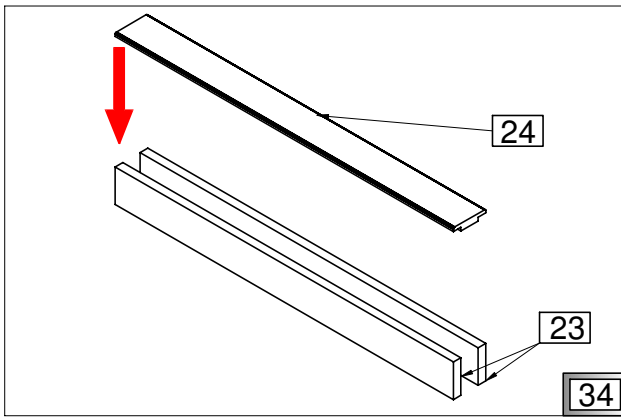
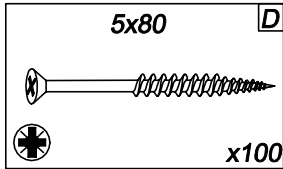
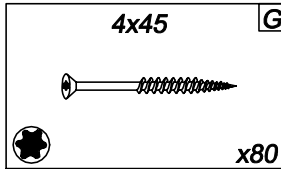
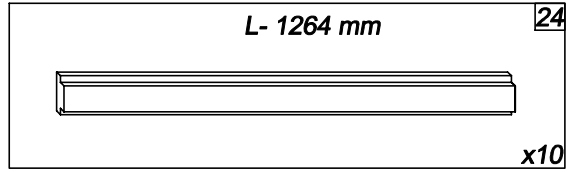
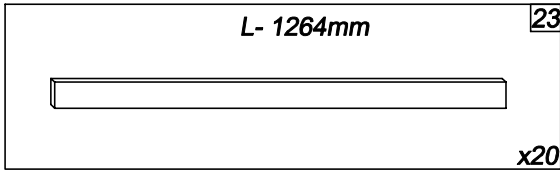

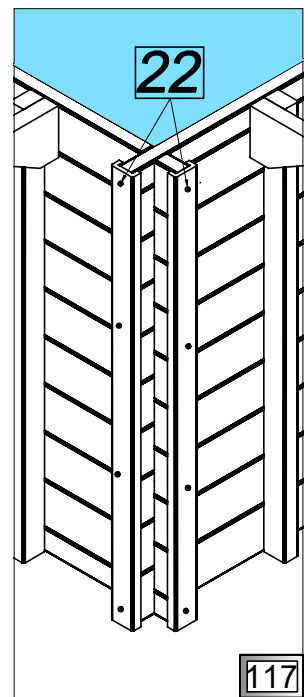
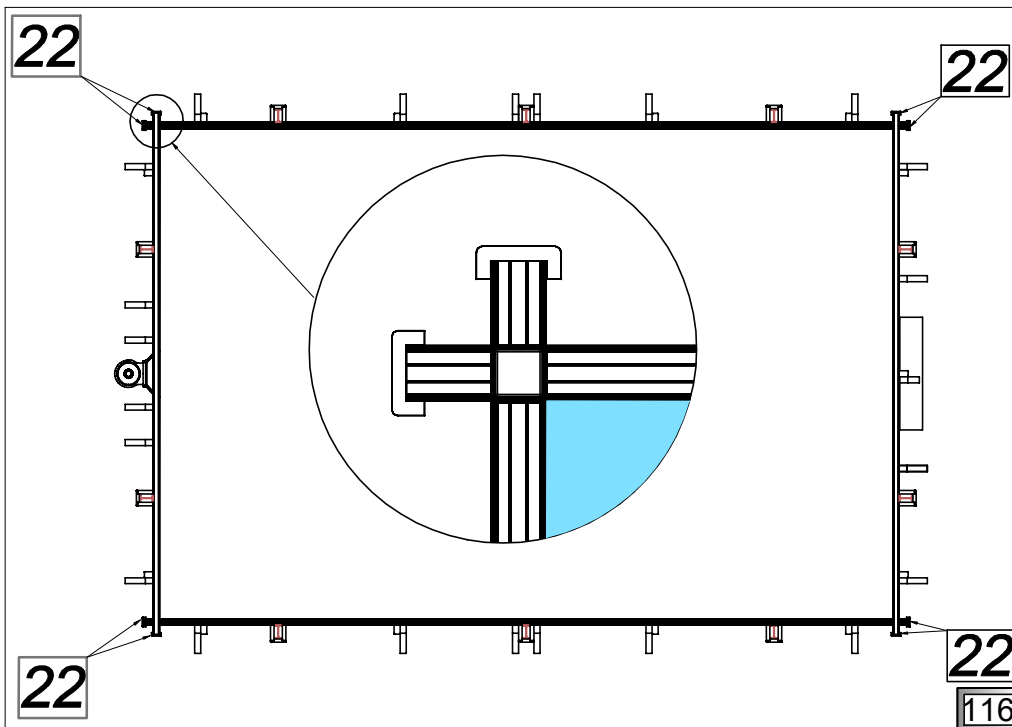
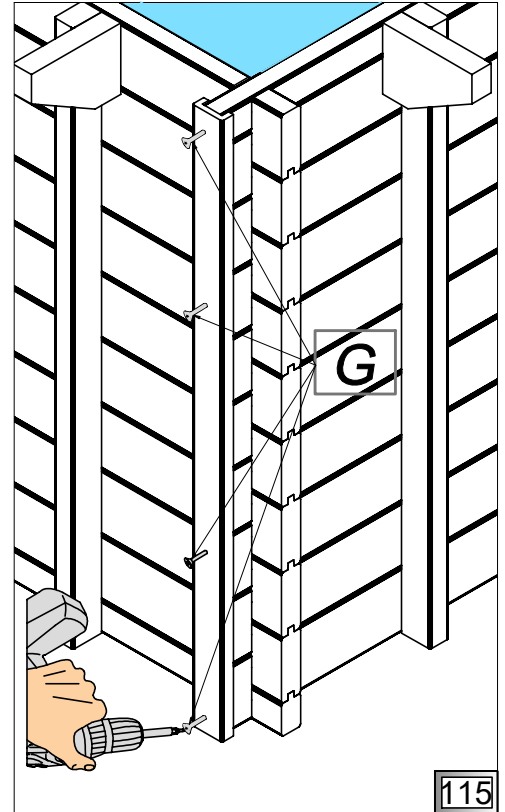
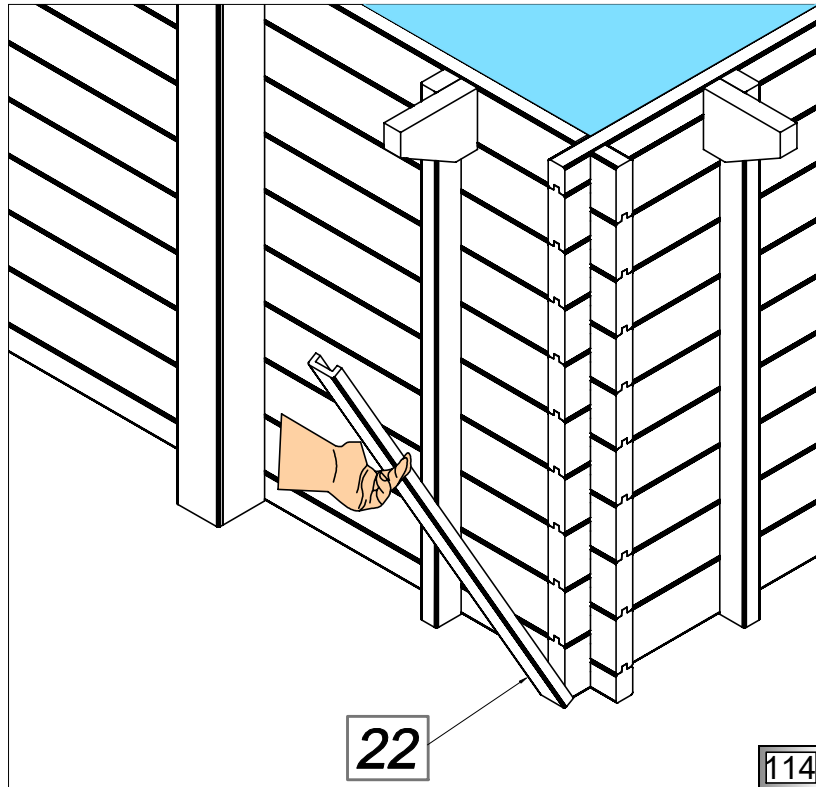
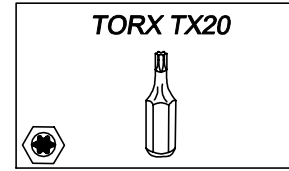
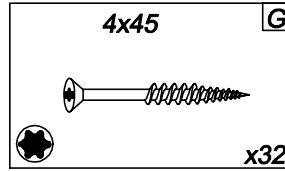
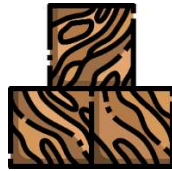

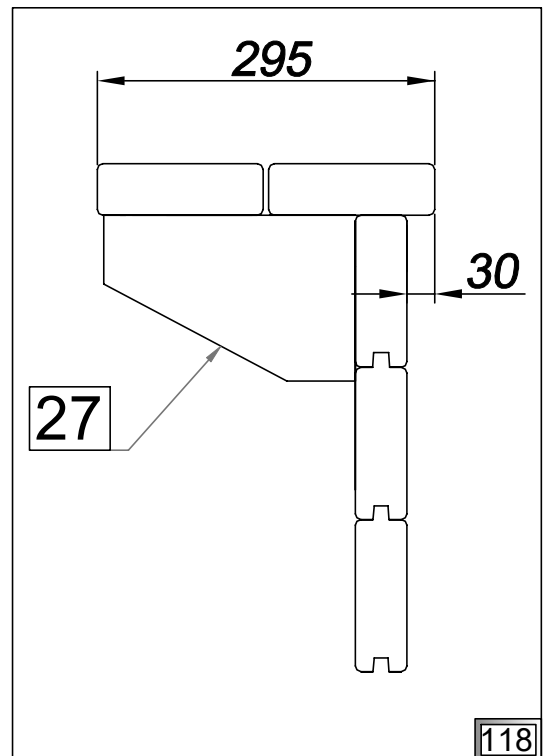
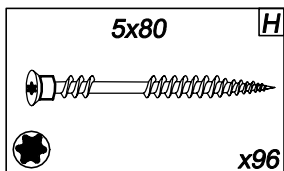
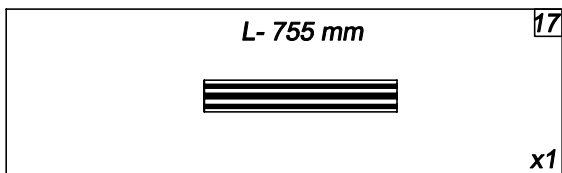
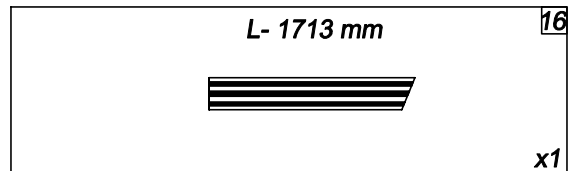
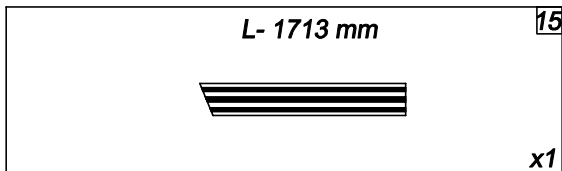
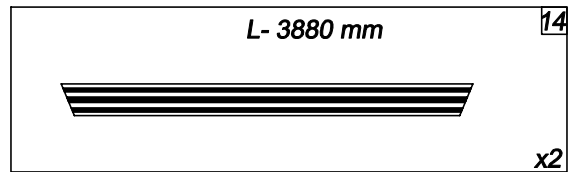
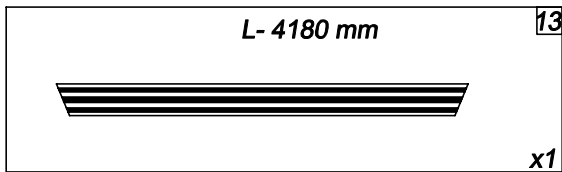
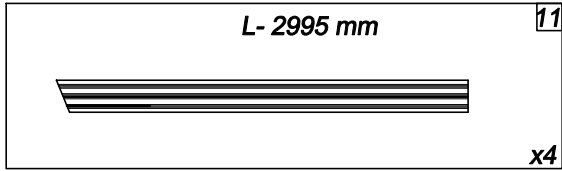
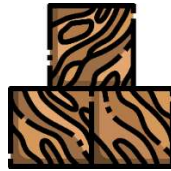

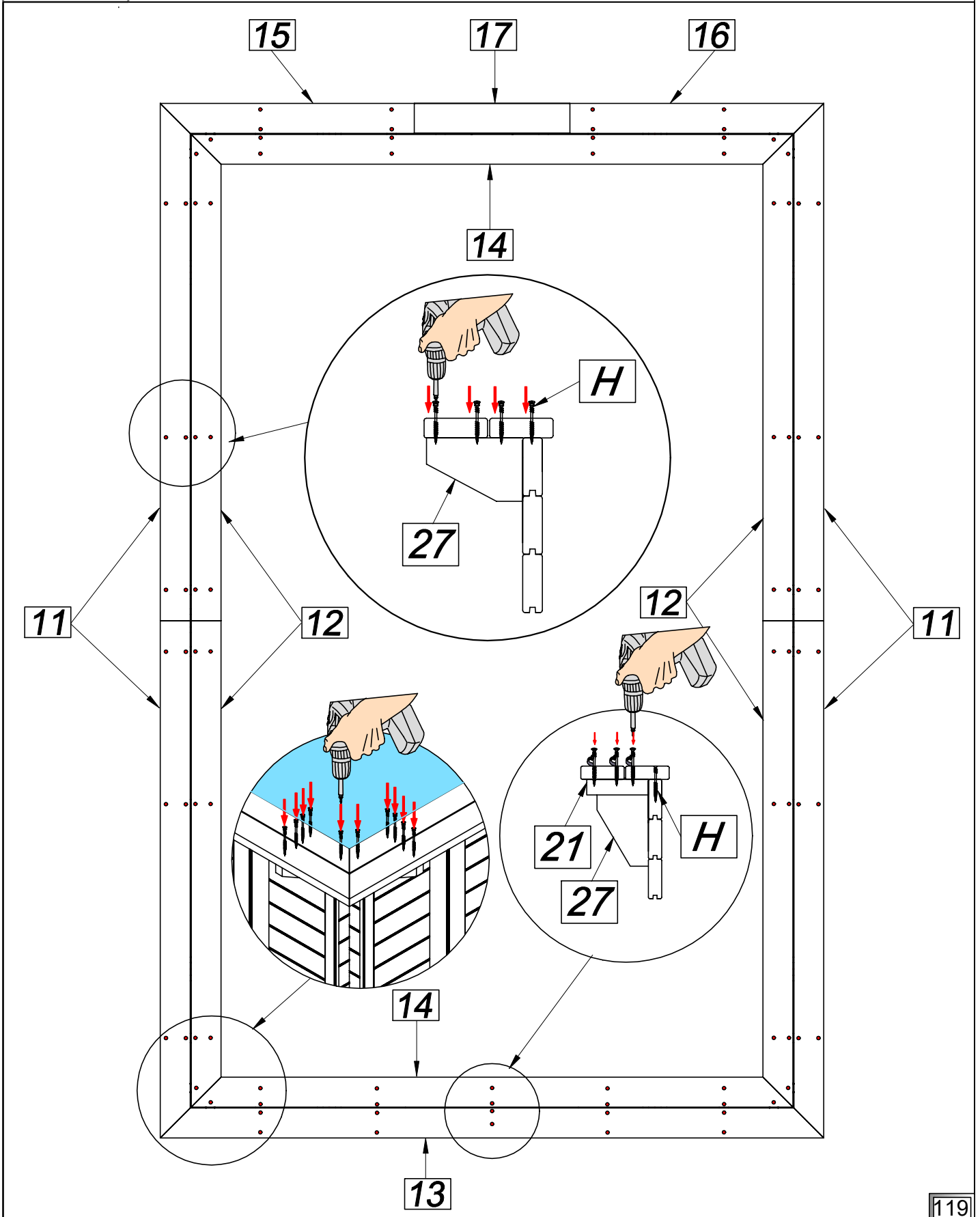
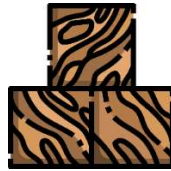

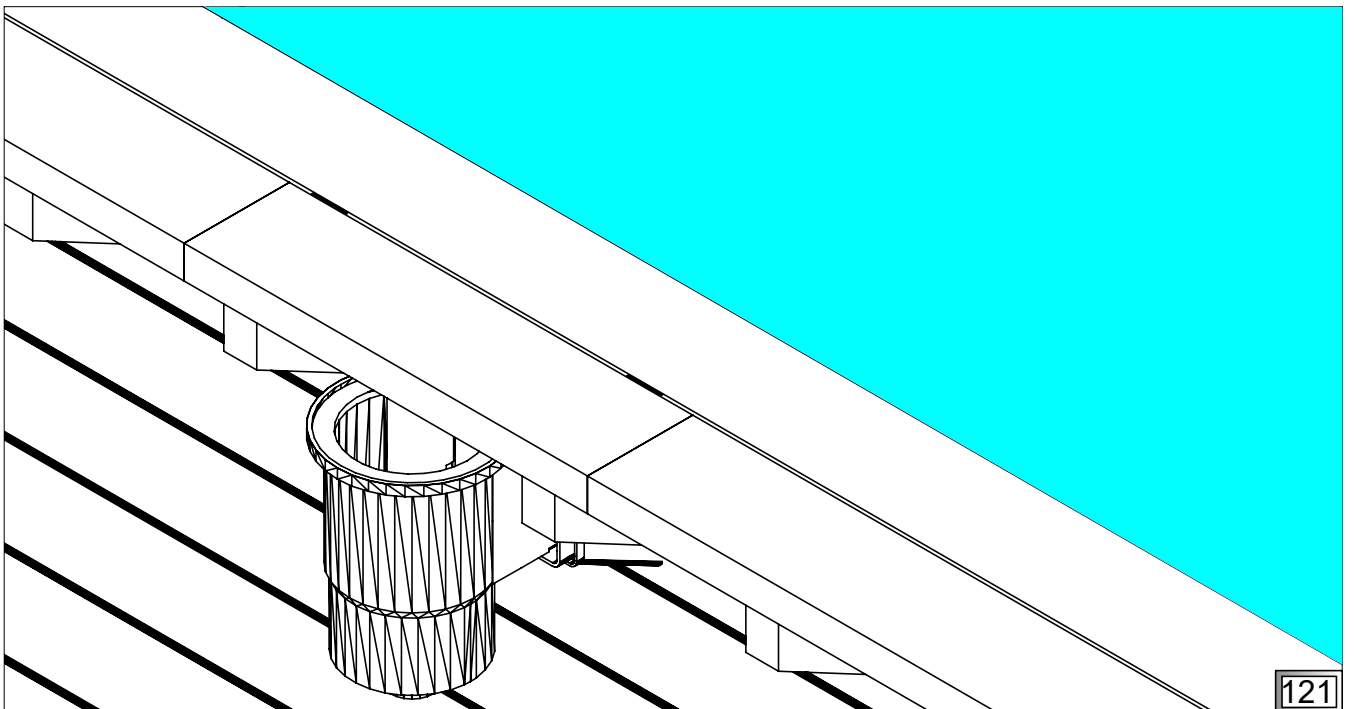
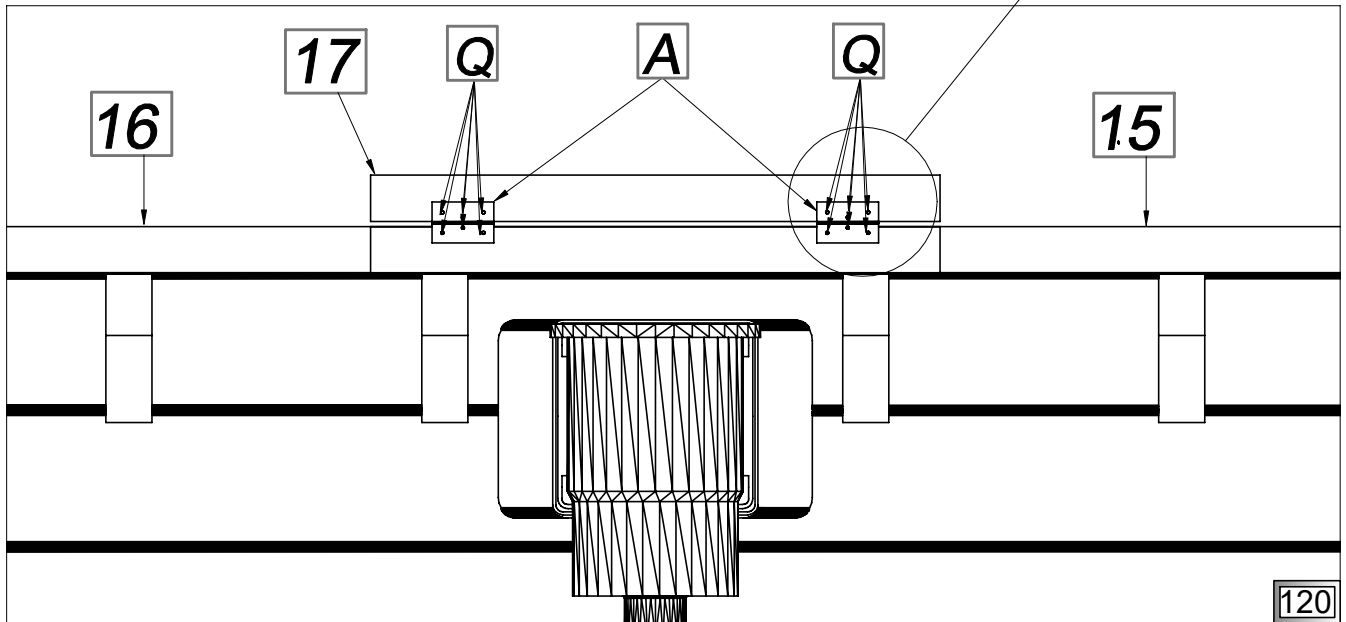
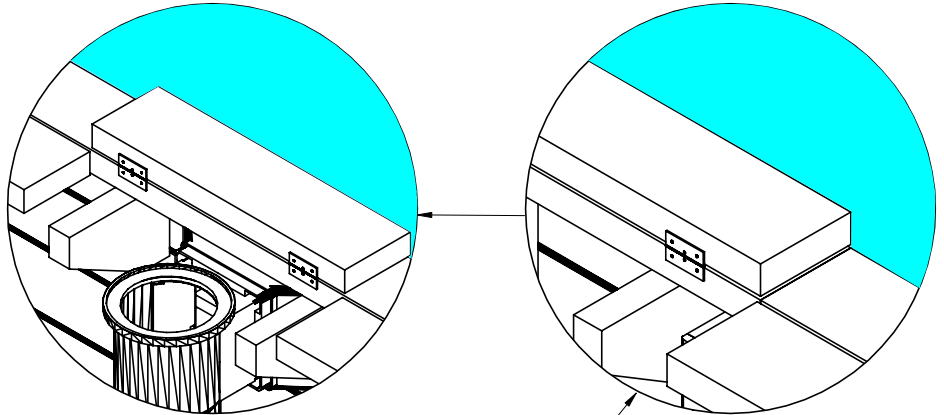
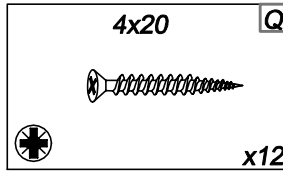
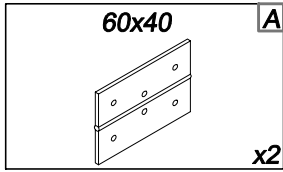
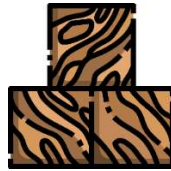

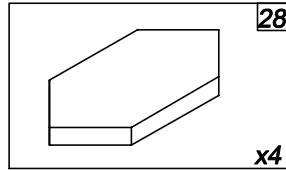
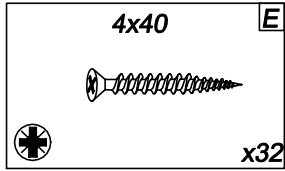
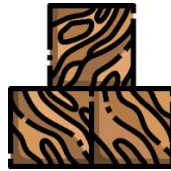

PL Widok od spodu tarasu.

GB View from the bottom of terrace.

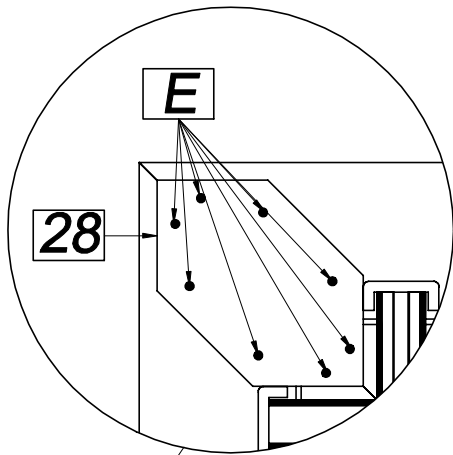
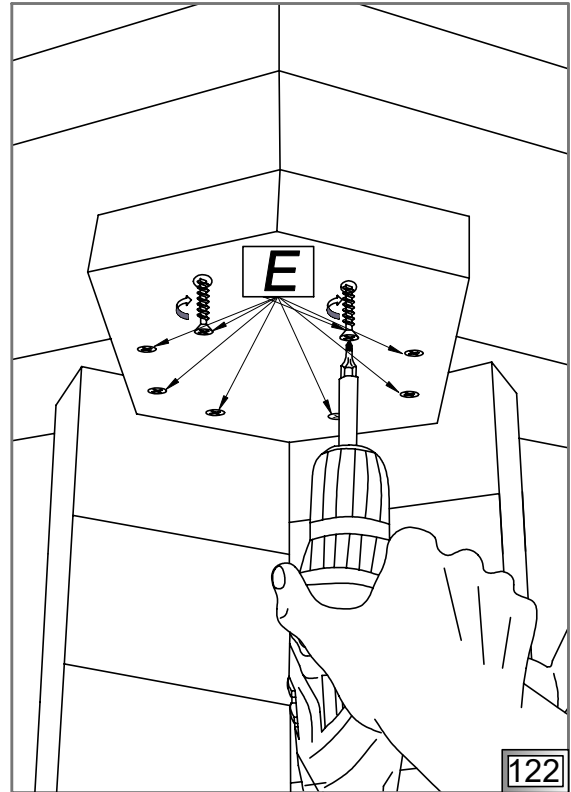

28

28

28

28

PL Schody drewniane

GB Wooden stairs

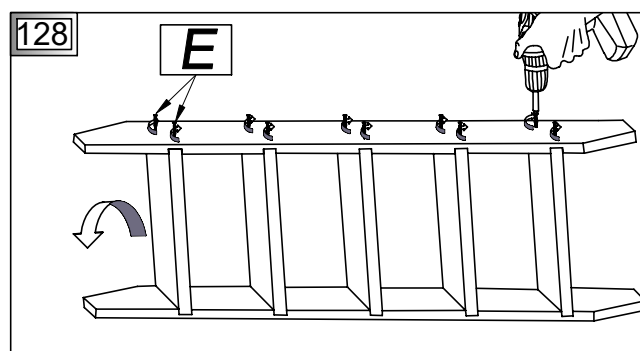
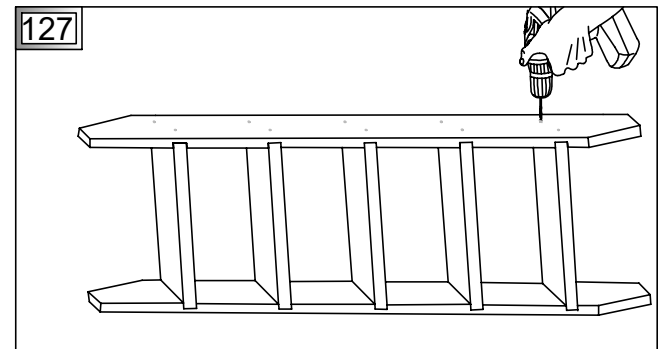
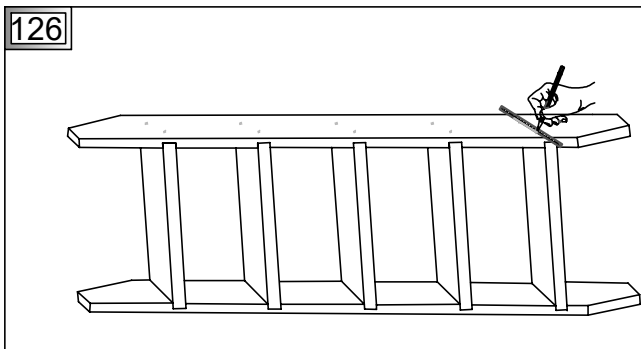
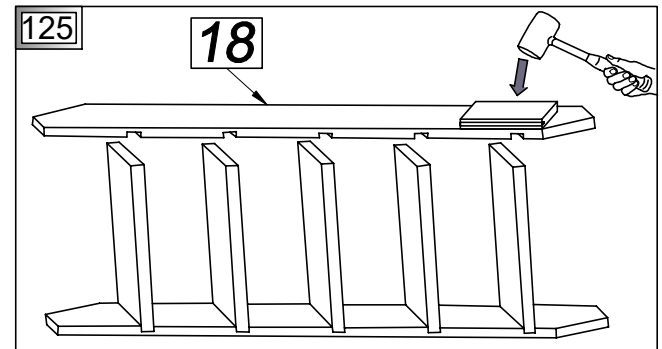
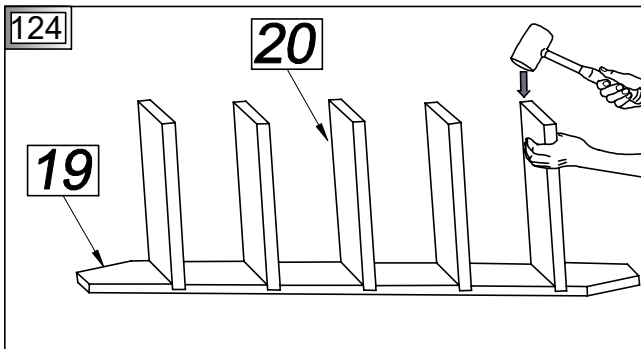
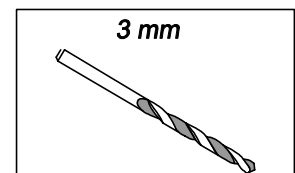
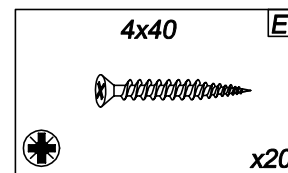
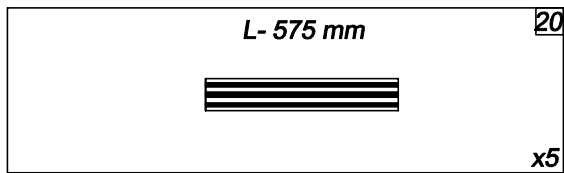
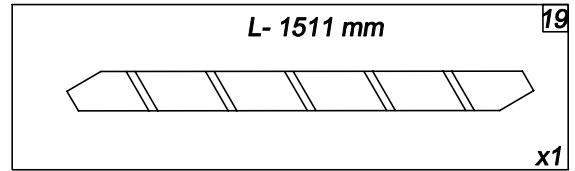
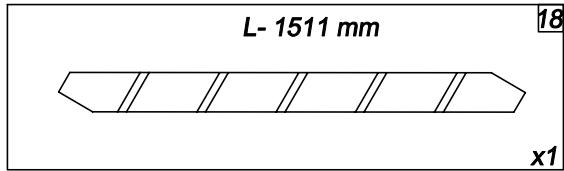
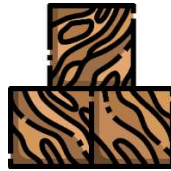

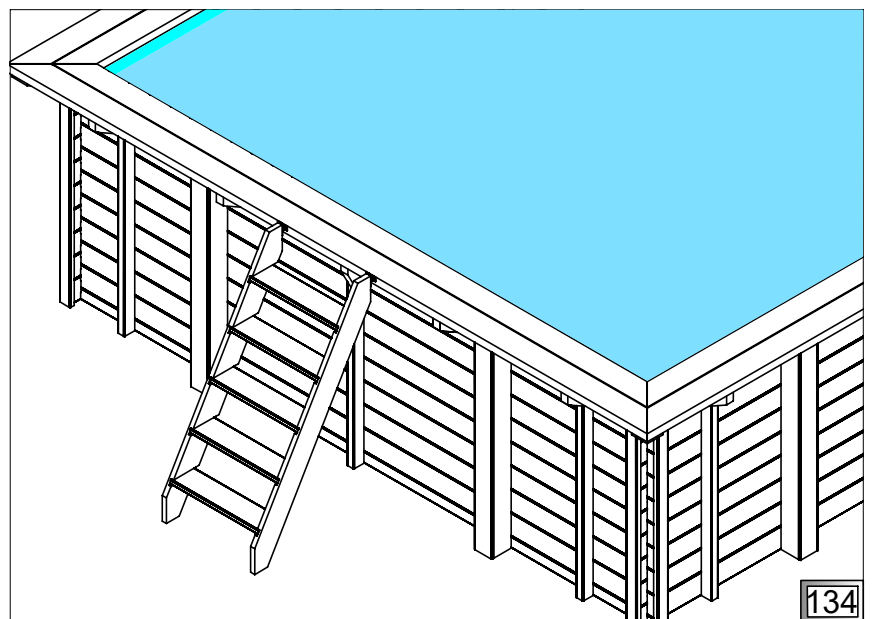
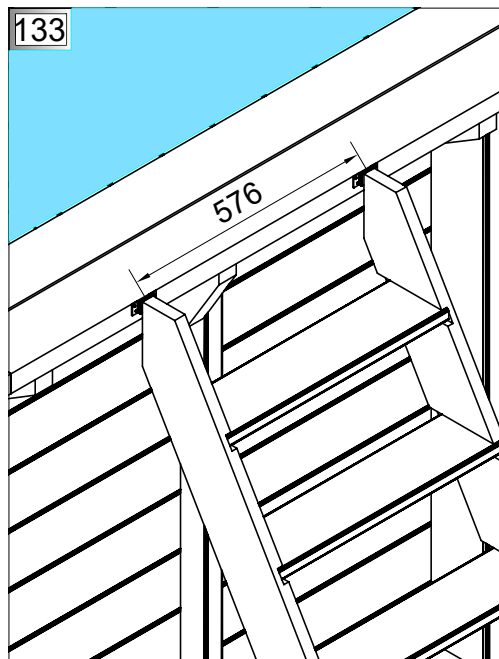
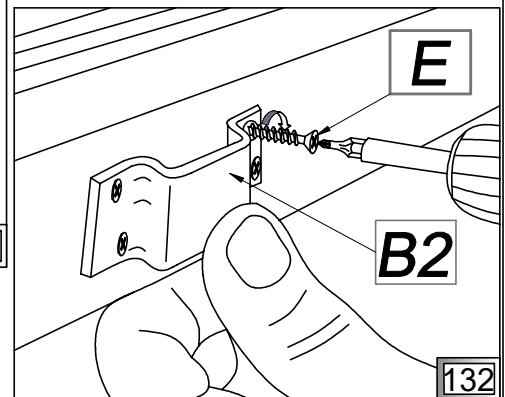
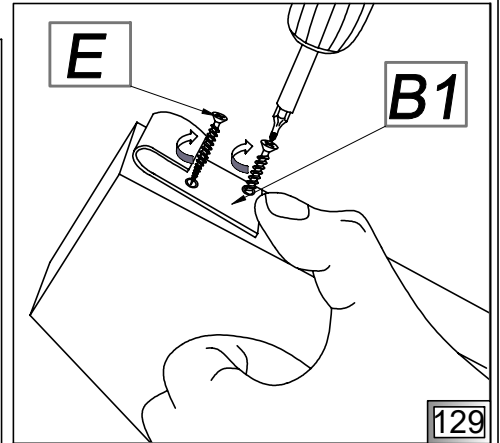
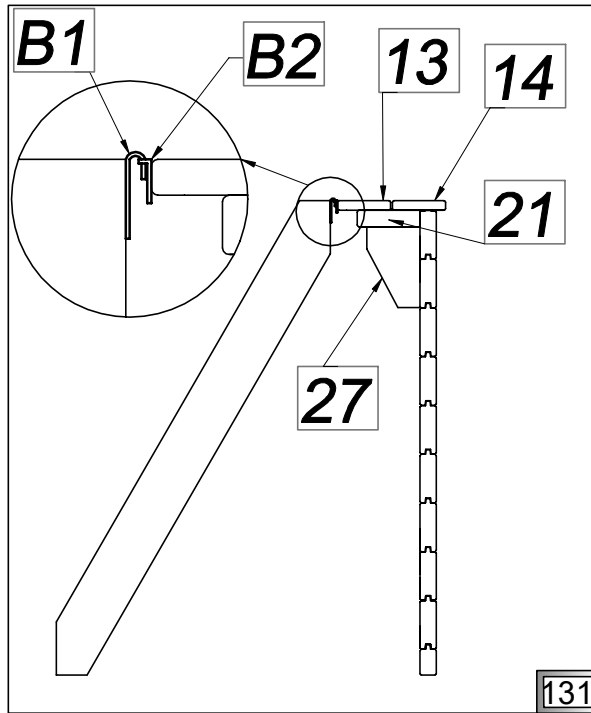
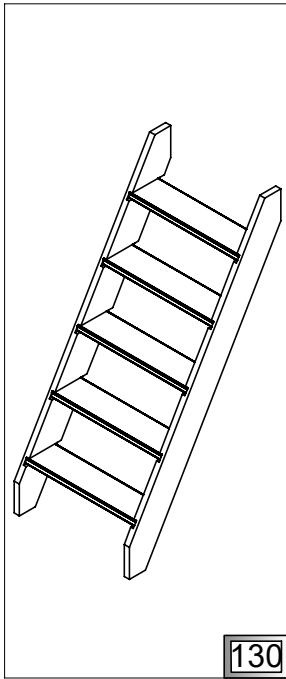
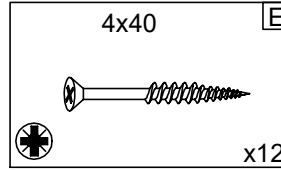
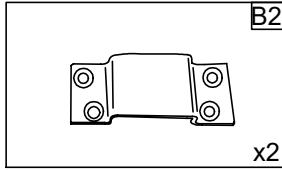
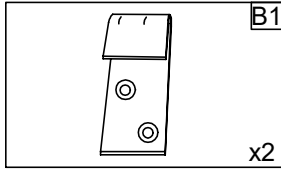
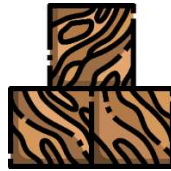

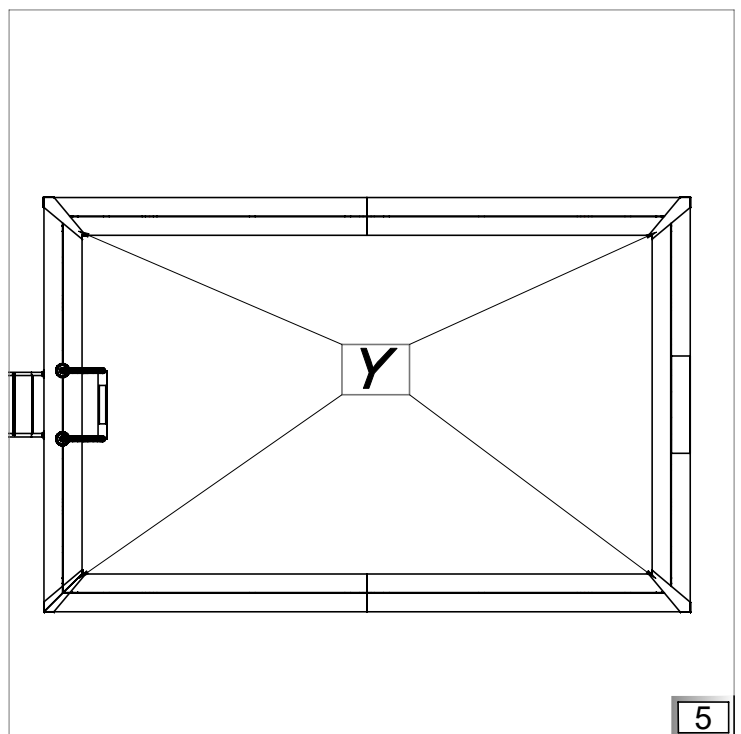
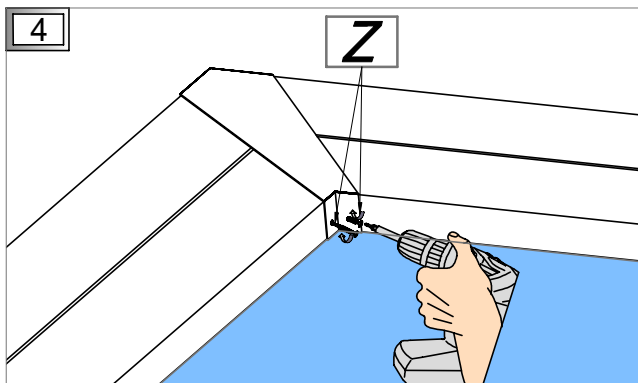
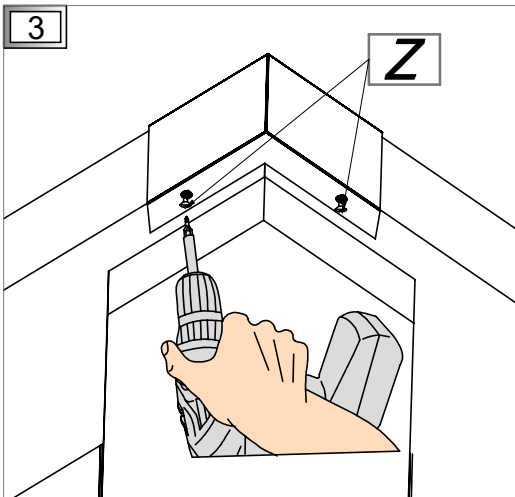
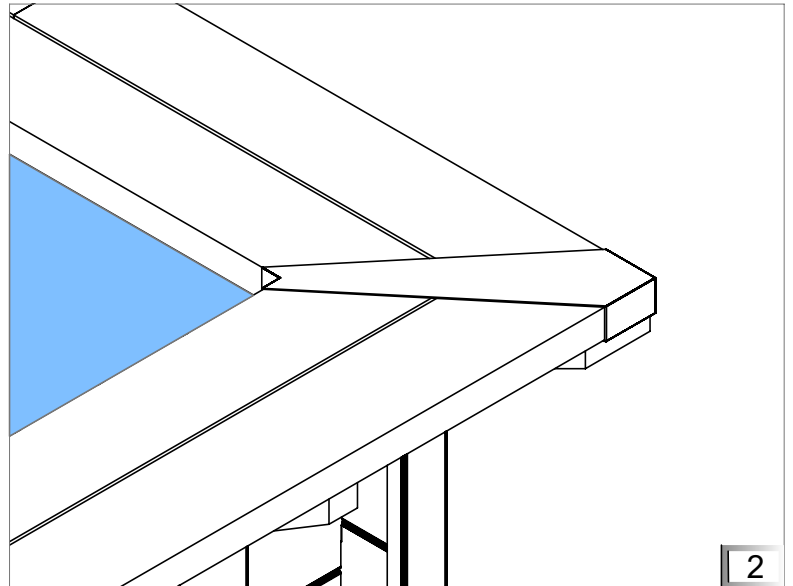
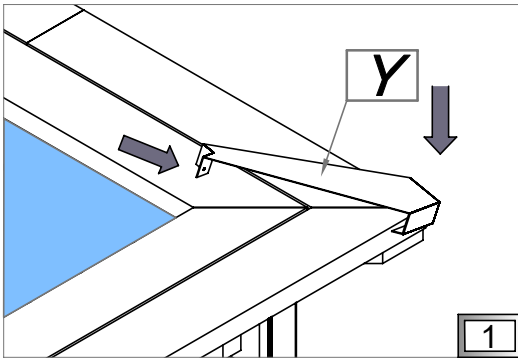
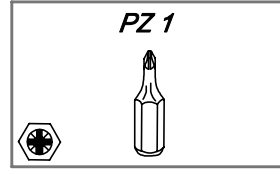
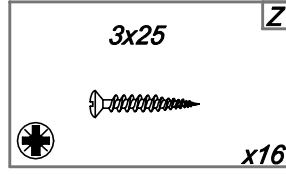
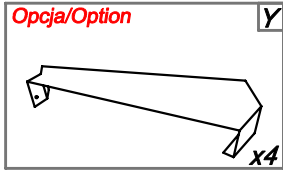

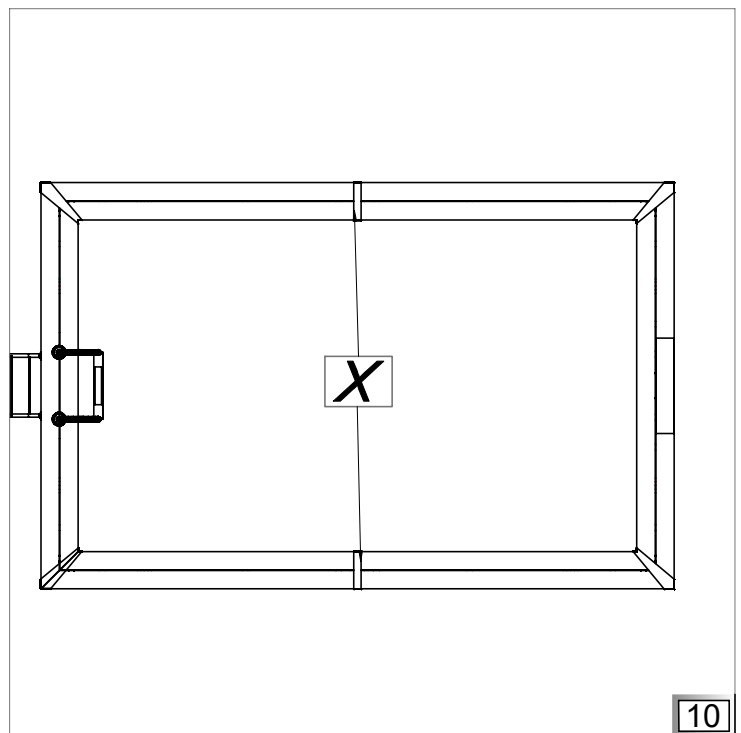
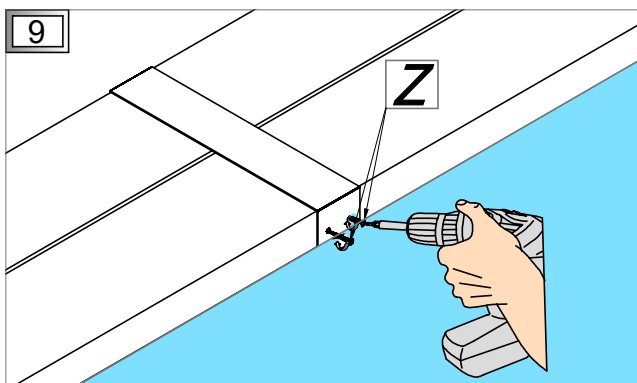
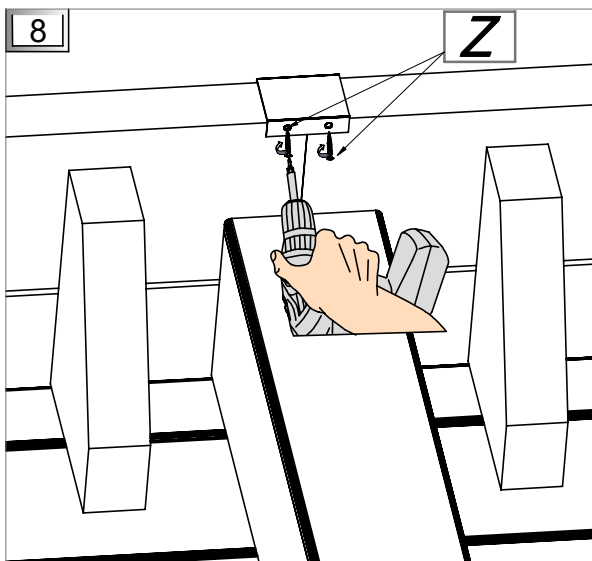
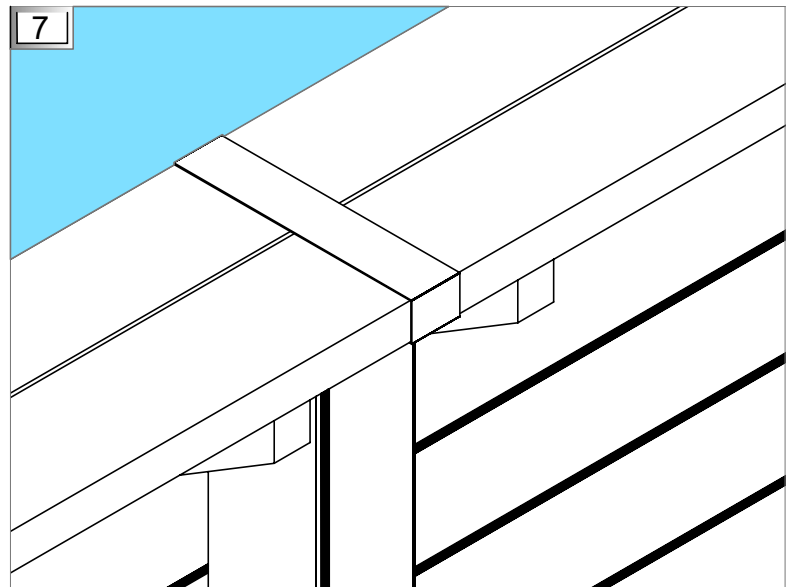
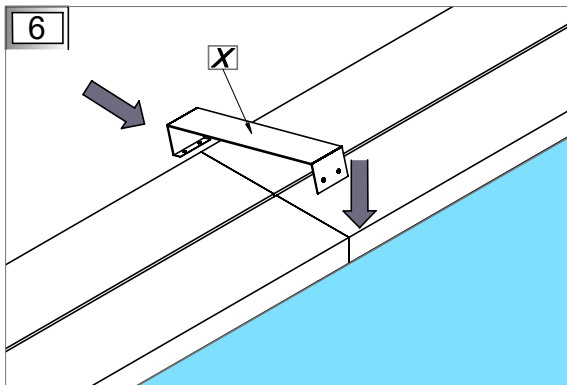
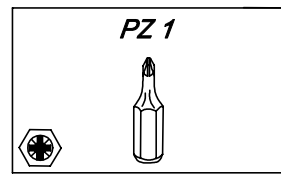
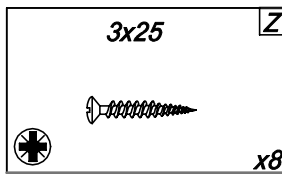
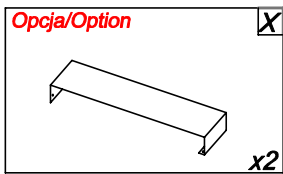

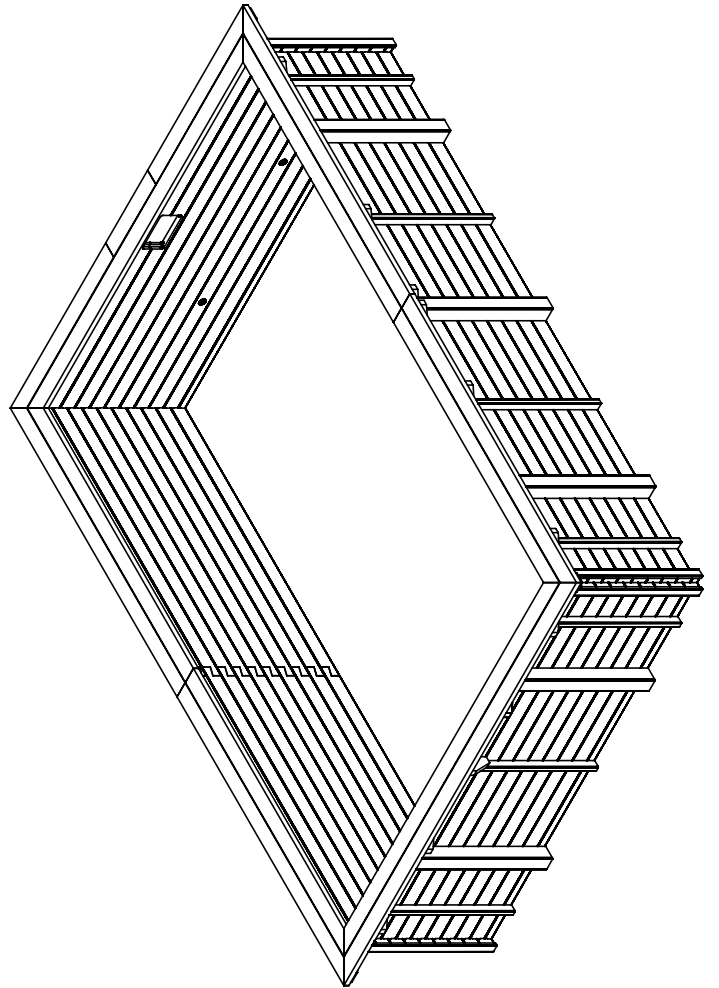
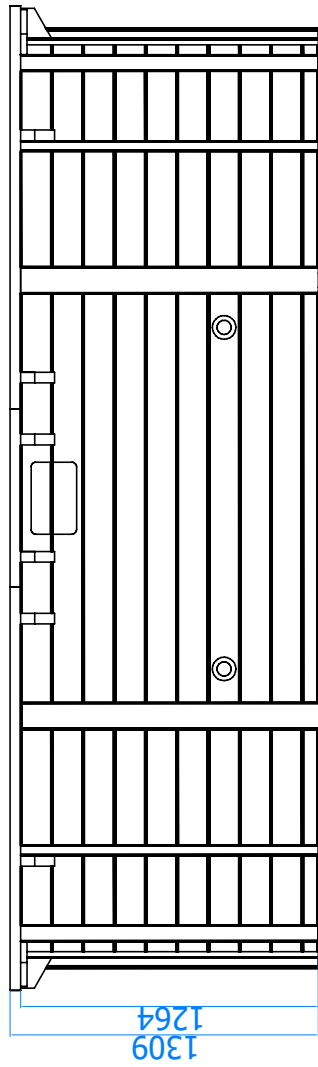
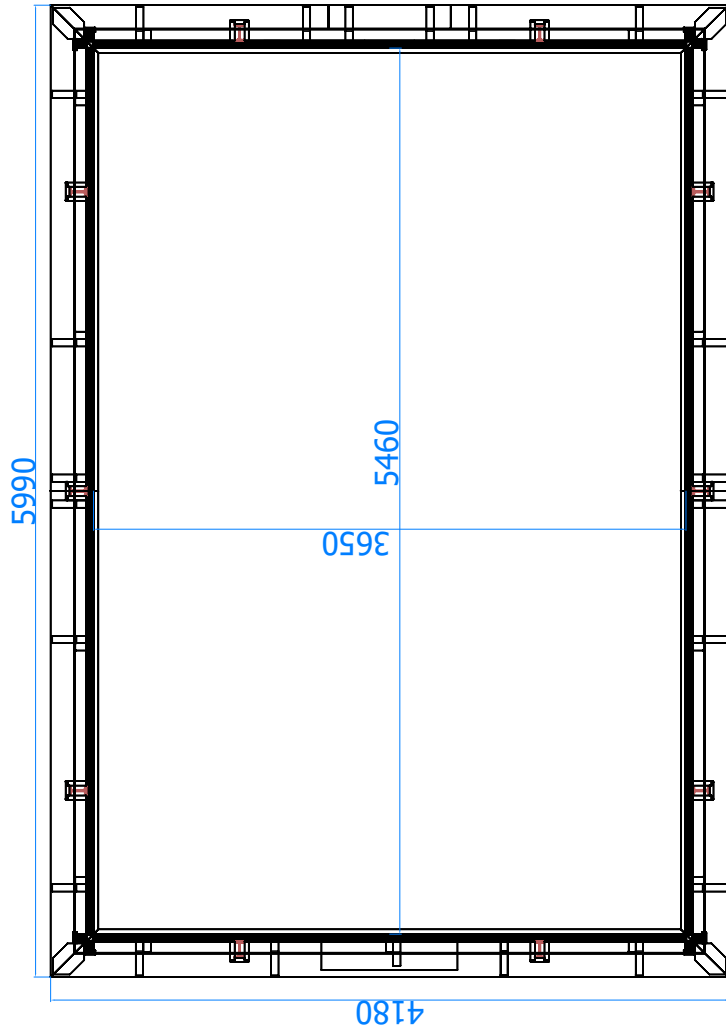

4140,00

3740,00

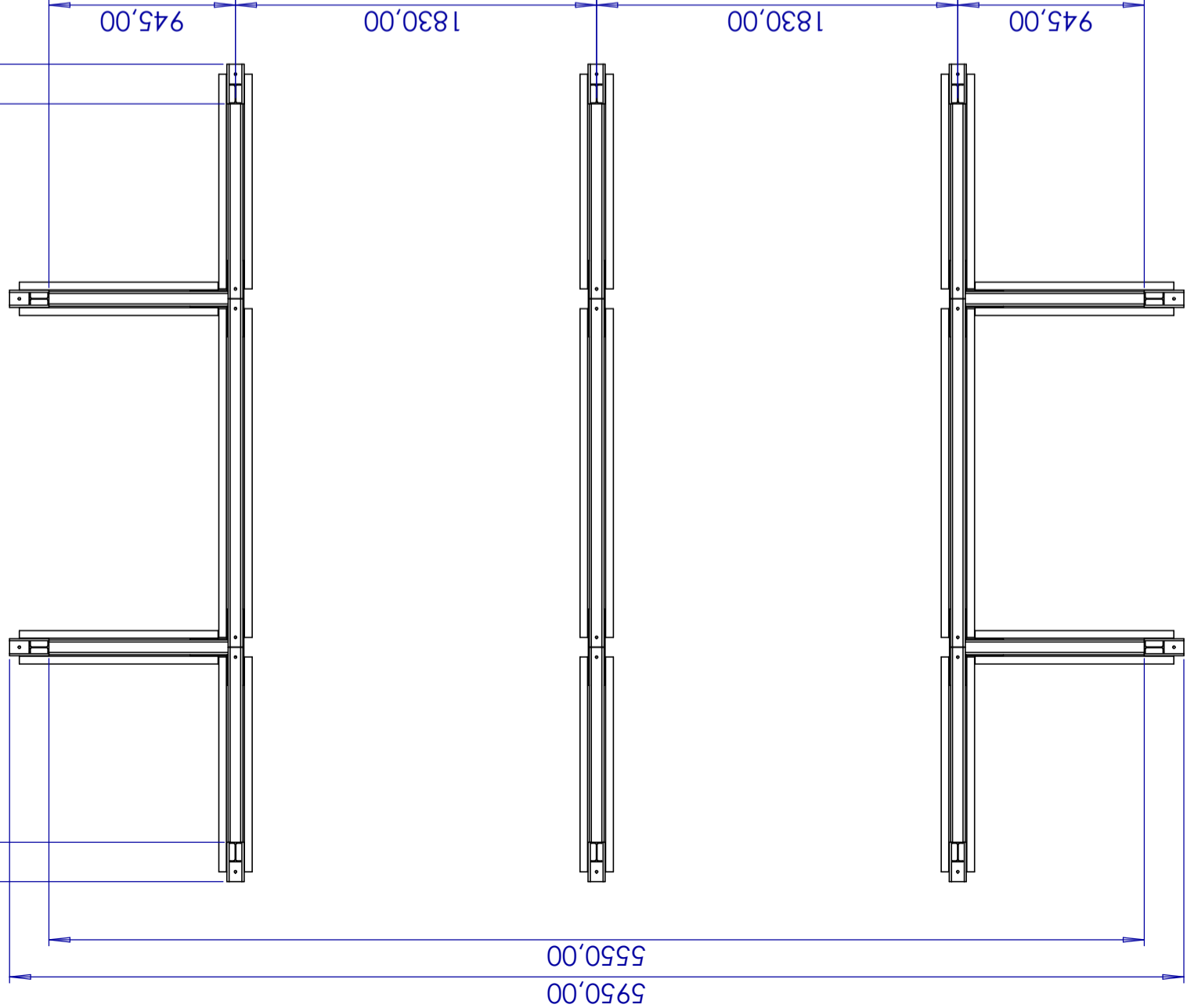

3740,00

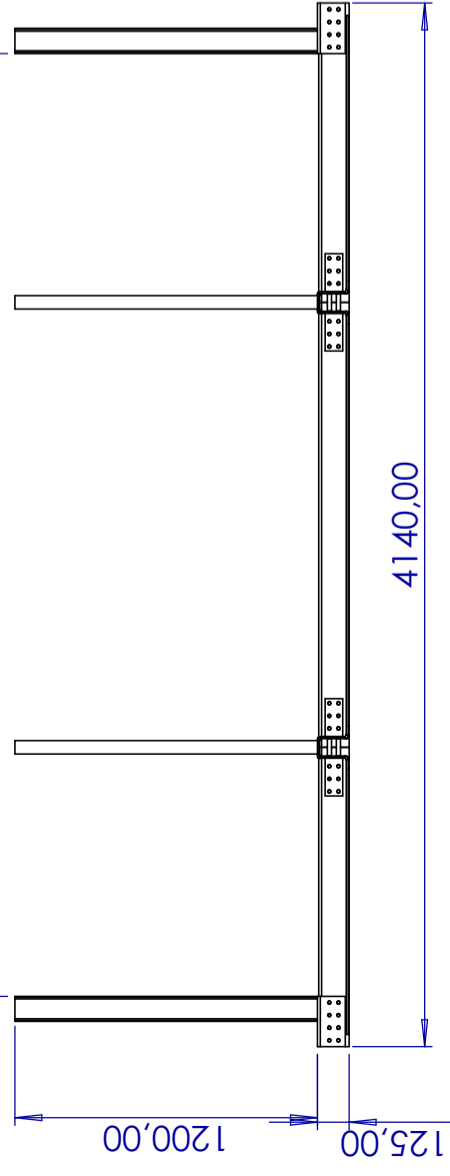

Codice Articolo 8030037

C.P.A. Srl

Via Don Demetrio Castelli, 71 - 12060 Roddi (CN) - Italy
Tel. +39.0173.615693 - Fax +39.0173.620922 - e-mail : ufficiotecnico@cpa-piscine.it

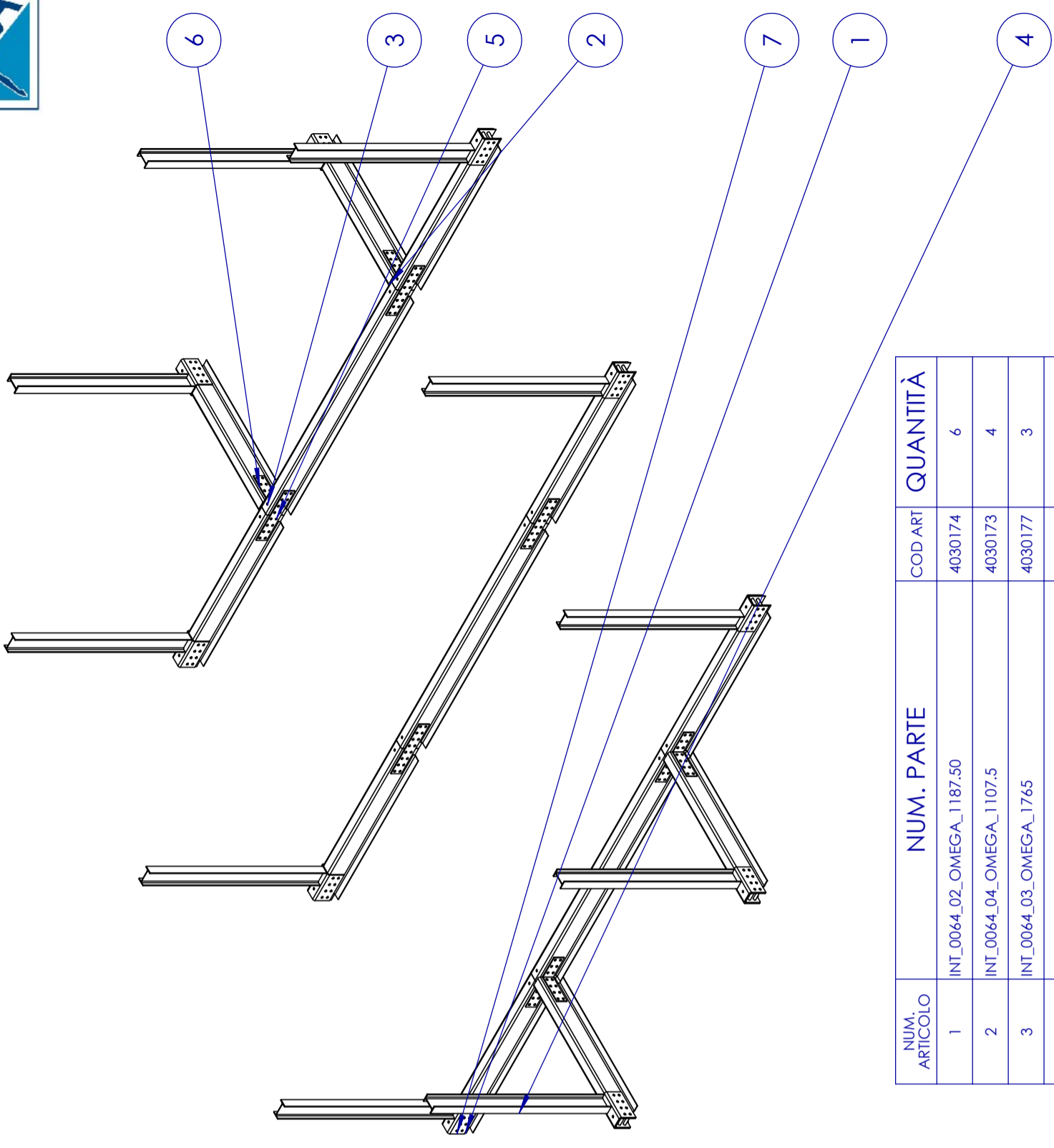

NUM. ARTICOLO	NUM. PARTE	COD.ART	QUANTITÀ
1	INT_0064_02_OMEGA_1187.50	4030174	6
2	INT_0064_04_OMEGA_1107.5	4030173	4
3	INT_0064_03_OMEGA_1765	4030177	3
4	INT_0050_02D_IPE_100_1200	8030101	10
5	INT_0022_13_PIASTRA_LINEARE_V01	4030039	8
6	INT_0022_14_PIASTRA_AD_ANGOLO_V01	4030040	8
7	INT_0022_09_PROFILO_U_V04	4030030	10
8	INT_0050_05_DISTANZIALE_OMEGA	1035885	40

21/07/2022
Rev. 00
foglio 1 di 2
scala
1:30
dis. n°
11A

INT_0064 cod. id. unico
 INT_0064_ASS14 cod. id parte
 C.P.A. SRL cod. id assieme committente
NIAGARA AUTOPORTANTE
KIT 600

Il presente disegno non può essere riprodotto, copiato, modificato o comunicato a terzi senza autorizzazione scritta.



C.P.A. Srl

Via Don Demetrio Castelli, 71 - 12060 Roddi (CN) - Italy
 Tel. +39.0173.615693 - Fax +39.0173.620922 - e-mail : ufficiotecnico@cpa-piscine.it

Il presente disegno non può essere riprodotto, copiato, modificato o comunicato a terzi senza autorizzazione scritta.

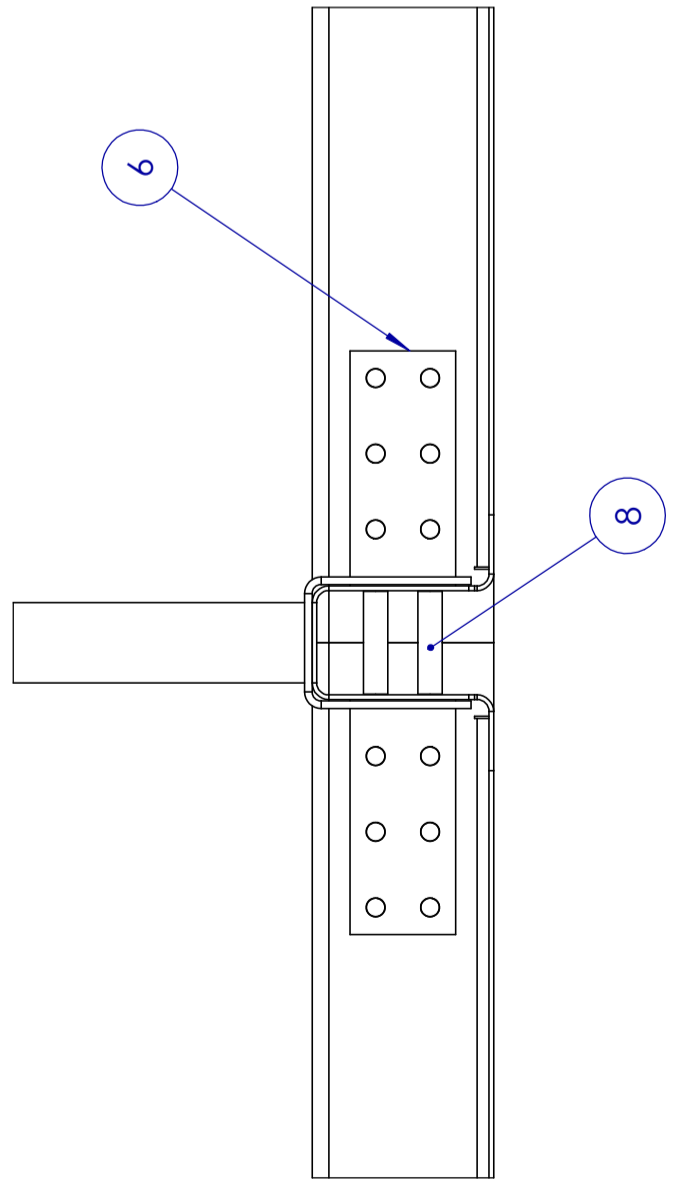
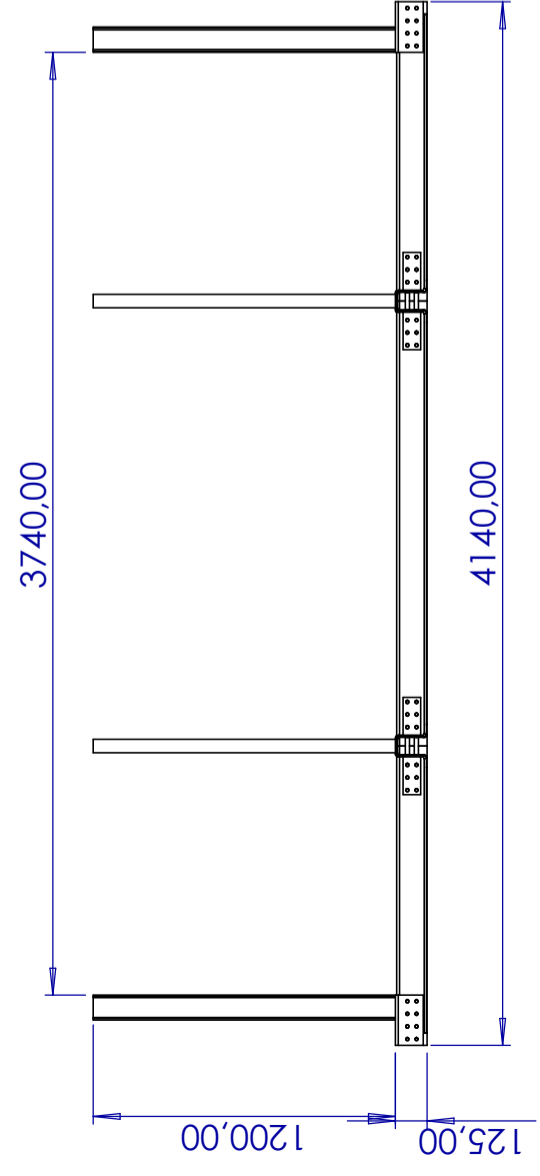
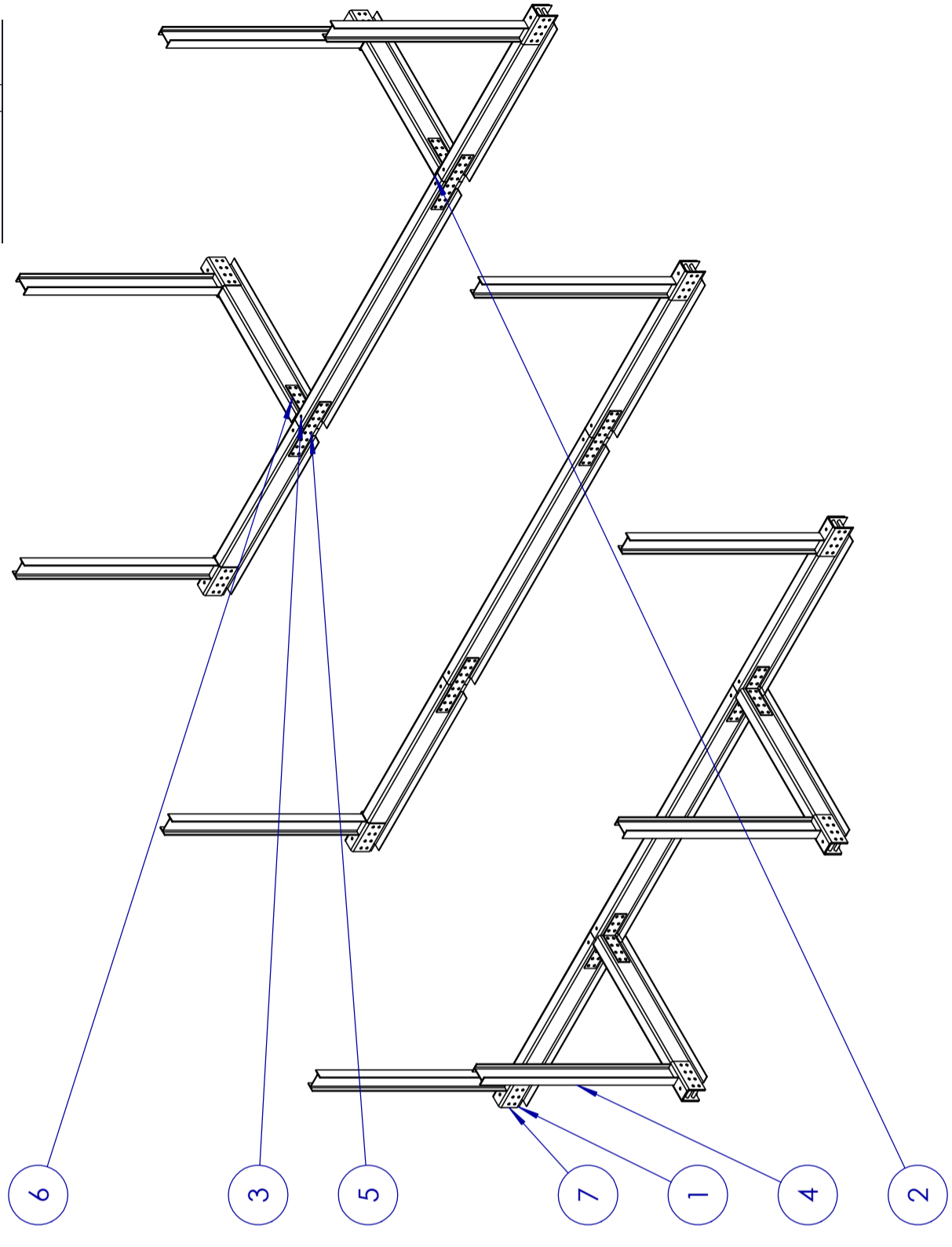

NUM. ARTICOLO	NUM. PARTE	COD. ART	QUANTITÀ
1	INT_0064_02_OMEGA_1187.50	4030174	6
2	INT_0064_04_OMEGA_1107.5	4030173	4
3	INT_0064_03_OMEGA_1765	4030177	3
4	INT_0050_02D_IPE_100_1200	8030101	10
5	INT_0022_13_PIASTRA_LINEARE_V01	4030039	8
6	INT_0022_14_PIASTRA_AD_ANGOLO_V01	4030040	8
7	INT_0022_09_PROFILO_U_V04	4030030	10
8	INT_0050_05_DISTANZIALE_OMEGA	1035885	40

N.B: I distanziali omega devono essere posizionati su ogni montante (n.4 pezzi/montante)

INT_0064 cod. id. unico
 INT_0064_ASS14 cod. id assieme
 C.P.A. SRL committente

Codice Articolo 8030037

NIAGARA AUTOPORTANTE
 KIT 600

21/07/2022
Rev. 00
foglio 2 di 2
scala
dis. n° 1:30
11B

PREPARAZIONE DELL'AREA DI POSA: SCAVO DELLE TRACCE PER ALLOGGIAMENTO DELLE TRAVI AD OMEGA NEL SUOLO



Via Don Demetrio Castelli, 71 - 12060 Roddi (CN) - Italy
Tel. +39.0173.615693 - Fax +39.0173.620922 - e-mail: ufficio tecnico@cpa-piscine.it

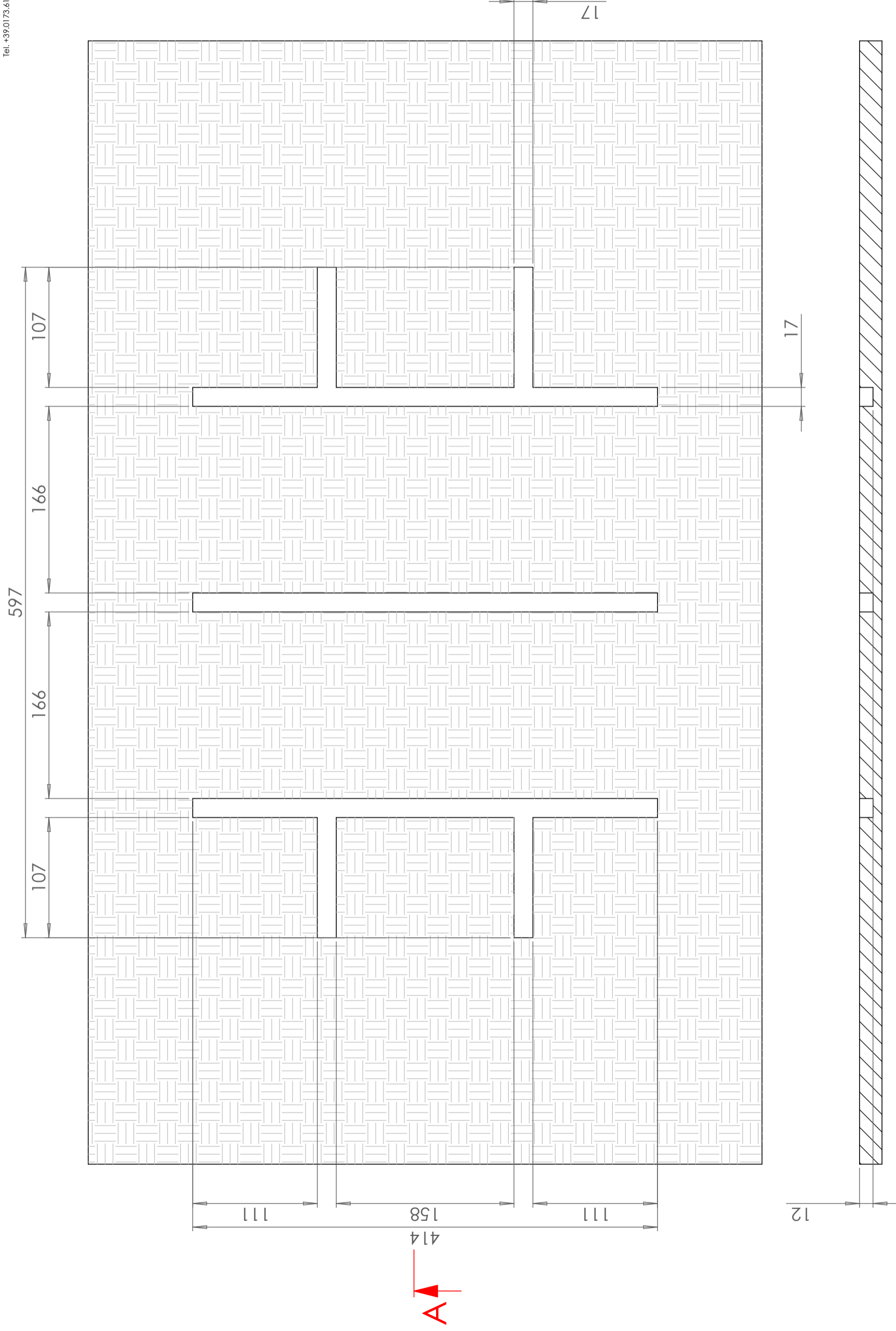

SEZIONE A-A

31/01/2023	Rev.	00	cod. art. CPA	
	foglio	1 di 1	cod. id parte	
	scala	1:100	cod. id assieme	
	dis. n°	00	committente	C.P.A. s.r.l.
			data revisione	

NIAGARA 600
SEZIONE SCAVO